



DSE Genset®



DEEP SEA ELECTRONICS PLC DSE4510 / DSE4520 Operator Manual

Document Number: 057-171

Author: Allan Jones

DEEP SEA ELECTRONICS PLC

Highfield House
 Hunmanby
 North Yorkshire
 YO14 0PH
 ENGLAND



Sales Tel: +44 (0) 1723 890099
 Sales Fax: +44 (0) 1723 893303

E-mail : sales@deepseapl.com
 Website : www.deepseapl.com

DSE4510/DSE4520 Operator Manual

© Deep Sea Electronics Plc

All rights reserved. No part of this publication may be reproduced in any material form (including photocopying or storing in any medium by electronic means or other) without the written permission of the copyright holder except in accordance with the provisions of the Copyright, Designs and Patents Act 1988.

Applications for the copyright holder's written permission to reproduce any part of this publication should be addressed to Deep Sea Electronics Plc at the address above.

The DSE logo is a UK registered trademarks of Deep Sea Electronics PLC.

Any reference to trademarked product names used within this publication is owned by their respective companies.

Deep Sea Electronics Plc reserves the right to change the contents of this document without prior notice.

Amendments List

Issue	Comments	Minimum Module version required	Minimum Configuration Suite Version required
1	Initial release	V1.0.0	
2	Added FPE item 11 – Display ph-ph	V1.0.0	

Typeface: The typeface used in this document is *Arial*. Care should be taken not to mistake the upper case letter I with the numeral 1. The numeral 1 has a top serif to avoid this confusion.

Clarification of notation used within this publication.



 NOTE:	Highlights an essential element of a procedure to ensure correctness.
 CAUTION!	Indicates a procedure or practice, which, if not strictly observed, could result in damage or destruction of equipment.
 WARNING!	Indicates a procedure or practice, which could result in injury to personnel or loss of life if not followed correctly.

TABLE OF CONTENTS

Section	Page
1 BIBLIOGRAPHY	6
1.1 INSTALLATION INSTRUCTIONS.....	6
1.2 MANUALS	6
1.3 TRAINING GUIDES	6
1.4 THIRD PARTY DOCUMENTS.....	6
2 INTRODUCTION	7
3 SPECIFICATIONS.....	8
3.1 PART NUMBERING	8
3.1.1 SHORT NAMES.....	8
3.2 TERMINAL SPECIFICATION	9
3.3 POWER SUPPLY REQUIREMENTS	9
3.4 GENERATOR VOLTAGE / FREQUENCY SENSING	9
3.5 GENERATOR CURRENT SENSING	10
3.5.1 VA RATING OF THE CTS	11
3.5.2 CT POLARITY	12
3.5.3 CT PHASING	12
3.5.4 CT CLASS	12
3.6 INPUTS	13
3.6.1 DIGITAL INPUTS.....	13
3.6.2 ANALOGUE INPUTS.....	13
3.6.2.1 OIL PRESSURE	13
3.6.2.2 COOLANT TEMPERATURE	13
3.6.2.3 FLEXIBLE SENSOR.....	14
3.6.2.4 CHARGE FAIL INPUT	14
3.7 OUTPUTS	14
3.7.1 OUTPUTS A & B.....	14
3.7.2 CONFIGURABLE OUTPUTS C,D,E & F (E & F 4520 ONLY).....	14
3.8 COMMUNICATION PORTS	15
3.9 COMMUNICATION PORT USAGE	15
3.9.1 CAN INTERFACE	15
3.9.2 USB CONNECTION	16
3.10 ACCUMULATED INSTRUMENTATION.....	16
3.11 DIMENSIONS AND MOUNTING	17
3.11.1 DIMENSIONS	17
3.11.2 PANEL CUTOUT	17
3.11.3 WEIGHT	17
3.11.4 FIXING CLIP	17
3.11.5 SILICON SEALING GASKET	18
3.12 APPLICABLE STANDARDS	19
3.12.1 ENCLOSURE CLASSIFICATIONS.....	20
3.12.2 NEMA CLASSIFICATIONS.....	21
4 INSTALLATION	22
4.1 TERMINAL DESCRIPTION	22
4.1.1 DC SUPPLY, FUEL AND START OUTPUTS, OUTPUTS C,D,E & F	23
4.1.2 ANALOGUE SENSOR.....	23
4.1.3 CONFIGURABLE DIGITAL INPUTS	24
4.1.4 CAN	24
4.1.5 GENERATOR / MAINS VOLTAGE SENSING	24
4.1.6 GENERATOR CURRENT TRANSFORMERS	25
4.1.7 PC CONFIGURATION INTERFACE CONNECTOR.....	26
4.2 TYPICAL WIRING DIAGRAMS	27
4.2.1 DSE4510 AUTOSTART MODULE	28
4.2.2 DSE4520 AUTO MAINS FAILURE MODULE.....	29

5	MODULE DISPLAY	30
5.1	INSTRUMENTATION ICONS	30
5.2	ACTIVE CONFIGURATION	31
5.3	MODE ICON	31
5.4	AUTO RUN ICON	31
5.5	BACKLIGHT	31
5.6	FAULT ICONS	32
6	DESCRIPTION OF CONTROLS	33
6.1	QUICKSTART GUIDE	34
6.1.1	STARTING THE ENGINE	34
6.1.2	STOPPING THE ENGINE	34
6.2	VIEWING THE INSTRUMENT PAGES	35
6.2.1	MENU	35
6.2.2	HOME	36
6.2.3	GENERATOR	36
6.2.4	MAINS (DSE4520 ONLY)	36
6.2.5	ENGINE	36
6.2.6	INFO	36
6.2.7	ENGINE DTC	37
6.2.8	EVENT	37
7	OPERATION	38
7.1	CONTROL PUSH-BUTTONS	38
7.2	STOP MODE	39
7.2.1	ECU OVERRIDE	40
7.3	AUTOMATIC MODE	41
7.3.1	WAITING IN AUTO MODE	41
7.3.2	STARTING SEQUENCE	41
7.3.3	ENGINE RUNNING	41
7.3.4	STOPPING SEQUENCE	42
7.4	MANUAL MODE	43
7.4.1	WAITING IN MANUAL MODE	43
7.4.2	STARTING SEQUENCE	43
7.4.3	ENGINE RUNNING	44
7.4.4	STOPPING SEQUENCE	44
7.5	MAINTENANCE ALARM	45
8	SCHEDULER	46
8.1.1	STOP MODE	46
8.1.2	AUTO MODE	46
9	FRONT PANEL CONFIGURATION	47
9.1	ACCESSING THE FRONT PANEL CONFIGURATION EDITOR	48
9.1.1	EDITING A PARAMETER	49
9.2	ADJUSTABLE PARAMETERS	50
9.3	PRE-COMMISSIONING	57
10	FAULT FINDING	58
10.1	CAN	59
10.2	INSTRUMENTS	59
10.3	MISCELLANEOUS	60
11	MAINTENANCE, SPARES, REPAIR AND SERVICING	61
11.1	PURCHASING ADDITIONAL CONNECTOR PLUGS FROM DSE	61
11.1.1	PACK OF PLUGS	61
11.1.2	INDIVIDUAL PLUGS	61
11.2	PURCHASING ADDITIONAL FIXING CLIPS FROM DSE	61
11.3	PURCHASING ADDITIONAL SEALING GASKET FROM DSE	61
12	WARRANTY	62

13	DISPOSAL	62
13.1	WEEE (WASTE ELECTRICAL AND ELECTRONIC EQUIPMENT)	62
13.2	ROHS (RESTRICTION OF HAZARDOUS SUBSTANCES).....	62

1 BIBLIOGRAPHY

This document refers to and is referred to by the following DSE publications which can be obtained from the DSE website: www.deepseapl.com

1.1 INSTALLATION INSTRUCTIONS

Installation instructions are supplied with the product in the box and are intended as a 'quick start' guide only.

DSE PART	DESCRIPTION
053-145	DSE4510/DSE4520 Installation Instructions

1.2 MANUALS

Product manuals are can be downloaded from the DSE website: www.deepseapl.com

DSE PART	DESCRIPTION
057-004	Electronic Engines and DSE Wiring
057-172	DSE4500 Series Configuration Software Manual

1.3 TRAINING GUIDES

Training Guides are produced to give 'handout' sheets on specific subjects during training sessions

DSE PART	DESCRIPTION
056-005	Using CTs With DSE Products
056-010	Overcurrent Protection
056-022	Breaker Control
056-029	Smoke Limiting
056-030	Module PIN Codes

1.4 THIRD PARTY DOCUMENTS

The following third party documents are also referred to:

REFERENCE	DESCRIPTION
ISBN 1-55937-879-4	IEEE Std C37.2-1996 IEEE Standard Electrical Power System Device Function Numbers and Contact Designations. Institute of Electrical and Electronics Engineers Inc
ISBN 0-7506-1147-2	Diesel generator handbook. L.L.J.Mahon
ISBN 0-9625949-3-8	On-Site Power Generation. EGSA Education Committee.

Product manuals are can be downloaded from the DSE website: www.deepseapl.com

2 INTRODUCTION

This document details the installation and operation requirements of the DSE4500 Series modules, part of the DSEgenset® range of products.

The manual forms part of the product and should be kept for the entire life of the product. If the product is passed or supplied to another party, ensure that this document is passed to them for reference purposes.

This is not a *controlled document*. You will not be automatically informed of updates. Any future updates of this document will be included on the DSE website at www.deepseapl.com

The DSE4500 series is designed to provide differing levels of functionality across a common platform. This allows the generator OEM greater flexibility in the choice of controller to use for a specific application.

The DSE4500 series module has been designed to allow the operator to start and stop the generator, and if required, transfer the load to the generator automatically. Additionally, the DSE4520 automatically starts and stops the generator set depending upon the status of the mains (utility) supply. The user also has the facility to view the system operating parameters via the LCD display.

The DSE4500 module monitors the engine, indicating the operational status and fault conditions, automatically shutting down the engine and giving a true first up fault condition of an engine. The LCD display indicates the fault.

The powerful ARM microprocessor contained within the module allows for incorporation of a range of complex features:

- *Icon based LCD display*
- **True RMS Voltage, Current monitoring (4510-02 and 4520-02 only)**
- *USB Communications*
- *Engine parameter monitoring.*
- *Fully configurable inputs for use as alarms or a range of different functions.*
- *Engine ECU interface to **electronic engines**.*

Using a PC and the DSE Configuration Suite software allows alteration of selected operational sequences, timers, alarms and operational sequences. Additionally, the module's integral front panel configuration editor allows adjustment of this information.

A robust plastic case designed for front panel mounting houses the module. Connections are via locking plug and sockets.

Access to critical operational sequences and timers for use by qualified engineers, can be protected by a security code. Module access can also be protected by PIN code. Selected parameters can be changed from the module's front panel.

The module is housed in a robust plastic case suitable for panel mounting. Connections to the module are via locking plug and sockets.

3 SPECIFICATIONS

3.1 PART NUMBERING

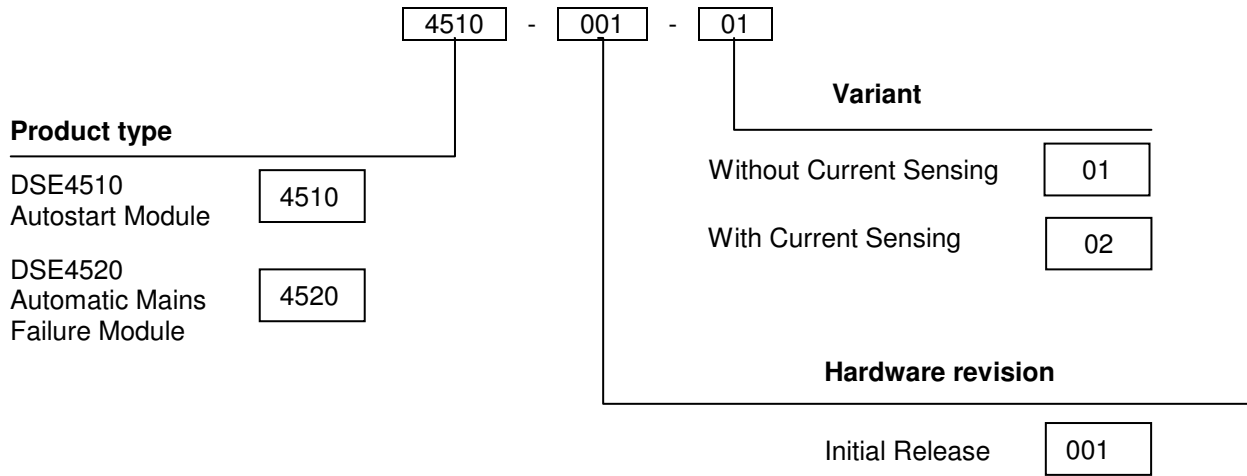

At the time of this document production, there have been no revisions to the module hardware.

3.1.1 SHORT NAMES

Short name	Description
DSE4000,DSE45xx	All modules in the DSE4000 range.
DSE4500,DSE45xx	All modules in the DSE4500 range.
DSE4510	DSE4510 module/controller
DSE4520	DSE4520 module/controller

3.2 TERMINAL SPECIFICATION

Connection type	Two part connector. <ul style="list-style-type: none"> • Male part fitted to module • Female part supplied in module packing case - Screw terminal, rising clamp, no internal spring. 	 <p>Example showing cable entry and screw terminals of a 10 way connector</p>
Minimum cable size	0.5mm ² (AWG 24)	
Maximum cable size	2.5mm ² (AWG 10)	

NOTE: For purchasing additional connector plugs from DSE, please see the section entitled Maintenance, Spares, Repair and Servicing elsewhere in this document.

3.3 POWER SUPPLY REQUIREMENTS

Minimum supply voltage	8V continuous
Cranking dropouts	Able to survive 0V for 100mS providing the supply was at least 10V before the dropout and recovers to 5V afterwards.
Maximum supply voltage	35V continuous (60V protection)
Reverse polarity protection	-35V continuous
Maximum operating current	85mA at 12V 96mA at 24V
Maximum standby current	47mA at 24V 51mA at 12V
Maximum Current when in Sleep Mode	35mA @ 12V 32mA @ 24V
Maximum Current when in Deep Sleep Mode	< 10µA@12V < 10µA@24V

Plant supply instrumentation display

Range	0V-70V DC (note Maximum continuous operating voltage of 35V DC)
Resolution	0.1V
Accuracy	1% full scale (±0.7V)

3.4 GENERATOR VOLTAGE / FREQUENCY SENSING

Specification

Measurement type	True RMS conversion
Sample Rate	5KHz or better
Harmonics	Up to 11 th
Input Impedance	300K Ω ph-N
Phase to Neutral	15V to 415V AC (absolute maximum)
Phase to Phase	25V to 720V AC (absolute maximum)
Common mode offset from Earth	100V AC (max)
Resolution	1V AC phase to neutral 2V AC phase to phase
Accuracy	$\pm 1\%$ of full scale phase to neutral $\pm 2\%$ of full scale phase to phase
Minimum frequency	3.5Hz
Maximum frequency	75.0Hz
Frequency resolution	0.1Hz
Frequency accuracy	$\pm 0.2\text{Hz}$

3.5 GENERATOR CURRENT SENSING

 **NOTE: Current Sensing is not available on models 4510-01 and 4520-01.**

Measurement type	True RMS conversion
Sample Rate	5KHz or better
Harmonics	Up to 10 th or better
Nominal CT secondary rating	5A
Maximum continuous current	5A
Overload Measurement	3 x Nominal Range setting
Absolute maximum overload	50A for 1 second
Burden	0.25VA (0.01 Ω current shunts)
common mode offset	$\pm 1\text{V}$ peak plant ground to CT common terminal
Resolution	0.5% of 5A
Accuracy	$\pm 1\%$ of Nominal (1A or 5A) (excluding CT error)

3.5.1 VA RATING OF THE CTS

The VA burden of the module on the CTs is 0.5VA. However depending upon the type and length of cabling between the CTs and the module, CTs with a greater VA rating than the module are required.

The distance between the CTs and the measuring module should be estimated and cross-referenced against the chart opposite to find the VA burden of the cable itself.

If the CTs are fitted within the alternator top box, the star point (common) of the CTs should be connected to system ground (earth) as close as possible to the CTs. This minimises the length of cable used to connect the CTs to the DSE module.

Example.

If 1.5mm² cable is used and the distance from the CT to the measuring module is 20m, then the burden of the cable alone is approximately 15VA. As the burden of the DSE controller is 0.5VA, then a CT with a rating of at least 15+0.5V = 15.5VA must be used. If 2.5mm² cables are used over the same distance of 20m, then the burden of the cable on the CT is approximately 7VA. CT's required in this instance is at least 7.5VA (7+0.5).

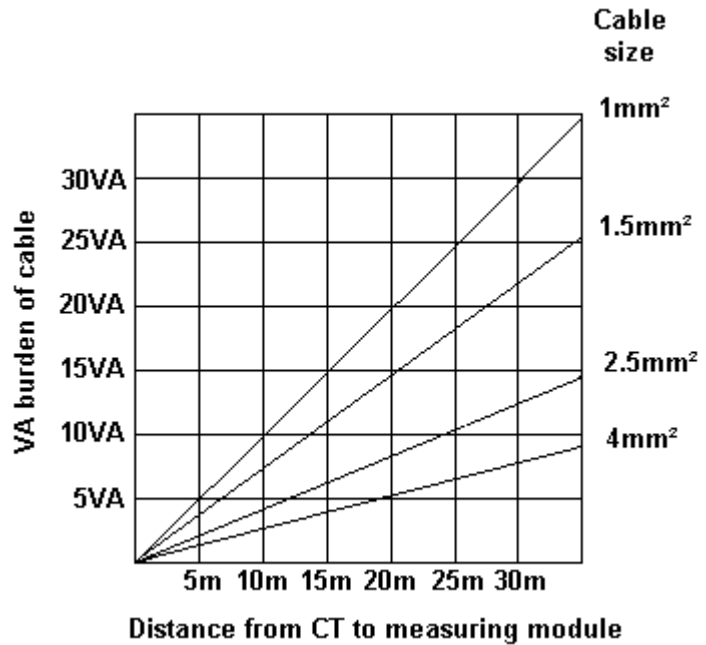

NOTE: Details for 4mm² cables are shown for reference only. The connectors on the DSE modules are only suitable for cables up to 2.5mm².

3.5.2 CT POLARITY

Take care to ensure the correct polarity of the CTs. Incorrect CT orientation will lead to negative kW readings when the set is supplying power. Take note that paper stick-on labels on CTs that show the orientation are often incorrectly placed on the CT (!). It is more reliable to use the labelling in the case moulding as an indicator to orientation (if available).

To test orientation, run the generator in island mode (not in parallel with any other supply) and load the generator to around 10% of the set rating. Ensure the DSE module shows positive kW for all three individual phase readings.

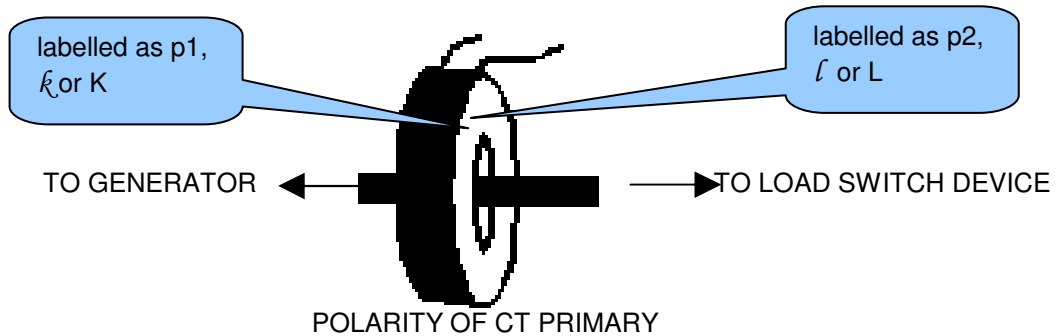

NOTE: Take care to ensure correct polarity of the CT primary as shown above. If in doubt, check with the CT supplier.

3.5.3 CT PHASING

Take particular care that the CTs are connected to the correct phases. For instance, ensure that the CT on phase 1 is connected to the terminal on the DSE module intended for connection to the CT for phase 1.

Additionally ensure that the voltage sensing for phase 1 is actually connected to generator phase 1. Incorrect connection of the phases as described above will result in incorrect power factor (pf) measurements, which in turn results in incorrect kW measurements.

One way to check for this is to make use of a single-phase load. Place the load on each phase in turn, run the generator and ensure the kW value appears in the correct phase. For instance if the load is connected to phase 3, ensure the kW figure appears in phase 3 display and not in the display for phase 1 or 2.

3.5.4 CT CLASS

Ensure the correct CT type is chosen. For instance if the DSE module is providing overcurrent protection, ensure the CT is capable of measuring the overload level you wish to protect against, and at the accuracy level you require.

For instance, this may mean fitting a protection class CT (P10 type) to maintain high accuracy while the CT is measuring overload currents.

Conversely, if the DSE module is using the CT for instrumentation only (current protection is disabled or not fitted to the controller), then measurement class CTs can be used. Again, bear in mind the accuracy you require. The DSE module is accurate to better than 1% of the full-scale current reading. To maintain this accuracy you should fit Class 0.5 or Class 1 CTs.

You should check with your CT manufacturer for further advice on selecting your CTs

3.6 INPUTS

3.6.1 DIGITAL INPUTS

Number	4 configurable inputs
Arrangement	Contact between terminal and ground
Low level threshold	3.2V minimum
High level threshold	8.1V maximum
Maximum input voltage	+60V DC with respect to plant supply negative
Minimum input voltage	-24V DC with respect to plant supply negative
Contact wetting current	6mA typical
Open circuit voltage	15V typical

3.6.2 ANALOGUE INPUTS

3.6.2.1 OIL PRESSURE

Configurable if engine ECU link provides oil pressure measurement

Measurement type	Resistance measurement by measuring voltage across sensor with a fixed current applied
Arrangement	Differential resistance measurement input
Measurement current	11mA 8.8mA@12V
Full scale	240Ω
Over range / fail	270Ω
Resolution	0.1 Bar (1-2 PSI)
Accuracy	±2% of full scale resistance (±4.8Ω) excluding transducer error
Max common mode voltage	±2V
Display range	13.7 bar (0-200 PSI) subject to limits of the sensor

3.6.2.2 COOLANT TEMPERATURE

Configurable if engine ECU link provides coolant temp measurement

Measurement type	Resistance measurement by measuring voltage across sensor with a fixed current applied
Arrangement	Differential resistance measurement input
Measurement current	11mA
Full scale	480Ω
Over range / fail	540Ω
Resolution	1°C (2°F)
Accuracy	+/-2% of full scale resistance (±9.6Ω) excluding transducer error
Max common mode voltage	±2V
Display range	0°C -140°C (32°F - 284°F) subject to limits of the sensor

3.6.2.3 FLEXIBLE SENSOR

Measurement type	Resistance measurement by measuring voltage across sensor with a fixed current applied
Arrangement	Differential resistance measurement input
Measurement current	11mA \pm 10%
Full scale	480 Ω
Over range / fail	540 Ω
Resolution	1%
Accuracy	\pm 2% of full scale resistance (\pm 9.6 Ω) excluding transducer error
Max common mode voltage	\pm 2V
Display range	0-250%

3.6.2.4 CHARGE FAIL INPUT

Minimum voltage	0V
Maximum voltage	35V (plant supply)
Resolution	0.2V
Accuracy	\pm 1% of max measured voltage
Excitation	Active circuit constant power output
Output Power	2.5W Nominal @12V and 24V
Current at 12V	210mA
Current at 24V	105mA

The charge fail input is actually a combined input and output. Whenever the generator is required to run, the terminal provides excitation current to the charge alternator field winding. When the charge alternator is correctly charging the battery, the voltage of the terminal is close to the plant battery supply voltage. In a failed charge situation, the voltage of this terminal is pulled down to a low voltage. It is this drop in voltage that triggers the *charge failure* alarm. The level at which this operates and whether this triggers a warning or shutdown alarm is configurable using the DSE Config Suite Software.

3.7 OUTPUTS

3.7.1 OUTPUTS A & B

Type	Normally used for Fuel / Start outputs. Fully configurable for other purposes if the module is configured to control an electronic engine.
Rating	10A for 10secs, 5A continuous.

3.7.2 CONFIGURABLE OUTPUTS C,D,E & F (E & F 4520 ONLY)

Type	Fully configurable, supplied from DC supply terminal 2.
Rating	2A continuous
Protection	Protected against over current & over temperature. Built in load dump feature.

3.8 COMMUNICATION PORTS

USB Port	USB2.0 Device for connection to PC running DSE configuration suite only Max distance 6m (yards)
CAN Port	Engine CAN Port Standard implementation of 'Slow mode', up to 250K bits/s Non-Isolated. Internal Termination provided (120Ω) Max distance 40m (133 feet)

▲NOTE: For additional length, the DSE124 CAN Extender is available. Please refer to DSE Publication: 057-116 DSE124 Operator Manual for more information.

3.9 COMMUNICATION PORT USAGE

3.9.1 CAN INTERFACE

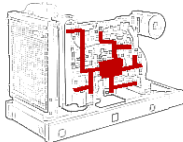

Modules are fitted with the CAN interface as standard and are capable of receiving engine data from engine CAN controllers compliant with the CAN standard.

CAN enabled engine controllers monitor the engine's operating parameters such as engine speed, oil pressure, engine temperature

(among others) in order to closely monitor and control the engine. The industry standard communications interface (CAN) transports data gathered by the engine controller interface. This allows generator controllers to access these engine parameters with no physical connection to the sensor device.

▲NOTE: For further details for connections to CAN enabled engines and the functions available with each engine type, refer to DSE Publication: Part No. 057-004 DSE Electronic Engines and DSE Wiring.

3.9.2 USB CONNECTION

The USB port is provided to give a simple means of connection between a PC and the controller. Using the DSE Configuration Suite Software, the operator is then able to control the module, starting or stopping the generator, selecting operating modes, etc. Additionally, the various operating parameters (such as output volts, oil pressure, etc.) of the remote generator are available to be viewed or changed.

To connect a module to a PC by USB, the following items are required:

- DSE4500 series module



- DSE Configuration Suite PC Software (Supplied on configuration suite software CD or available from www.deepseapl.com).



- USB cable Type A to Type B. (This is the same cable as often used between a PC and a USB printer)



DSE can supply this cable if required :
PC Configuration interface lead (USB type A – type B) DSE Part No 016-125

NOTE: The DC supply must be connected to the module for configuration by PC.

NOTE: Please refer to DSE Publication: 057-172 DSE4510 / DSE4520 Software Manual for further details on configuring, monitoring and control.

3.10 ACCUMULATED INSTRUMENTATION

NOTE: When an accumulated instrumentation value exceeds the maximum number as listed below, it will reset and begin counting from zero again.

Engine hours run	Maximum 99999 hrs 59 minutes (approximately 11yrs 4months)
Number of starts	1,000,000 (1 million)

The number of logged Engine Hours and Number of Starts can be set/reset using the DSE Configuration Suite PC software. Depending upon module configuration, this may have been PIN number locked by your generator supplier

3.11 DIMENSIONS AND MOUNTING

3.11.1 DIMENSIONS

140.0mm x 113mm x 43mm (5.5" x 4.4" x 1.7")

3.11.2 PANEL CUTOUT

118mm x 92mm (4.6" x 3.6")

3.11.3 WEIGHT

0.16kg (0.35lb)

3.11.4 FIXING CLIP

The module is held into the panel fascia using the supplied fixing clips.

- Withdraw the fixing clip screw (turn anticlockwise) until only the pointed end is protruding from the clip.
- Insert the three 'prongs' of the fixing clip into the slots in the side of the module case.
- Pull the fixing clip backwards (towards the back of the module) ensuring all three prongs of the clip are inside their allotted slots.
- Turn the fixing clip screws clockwise until they make contact with the panel fascia.
- Turn the screws a little more to secure the module into the panel fascia. Care should be taken not to over tighten the fixing clip screws.

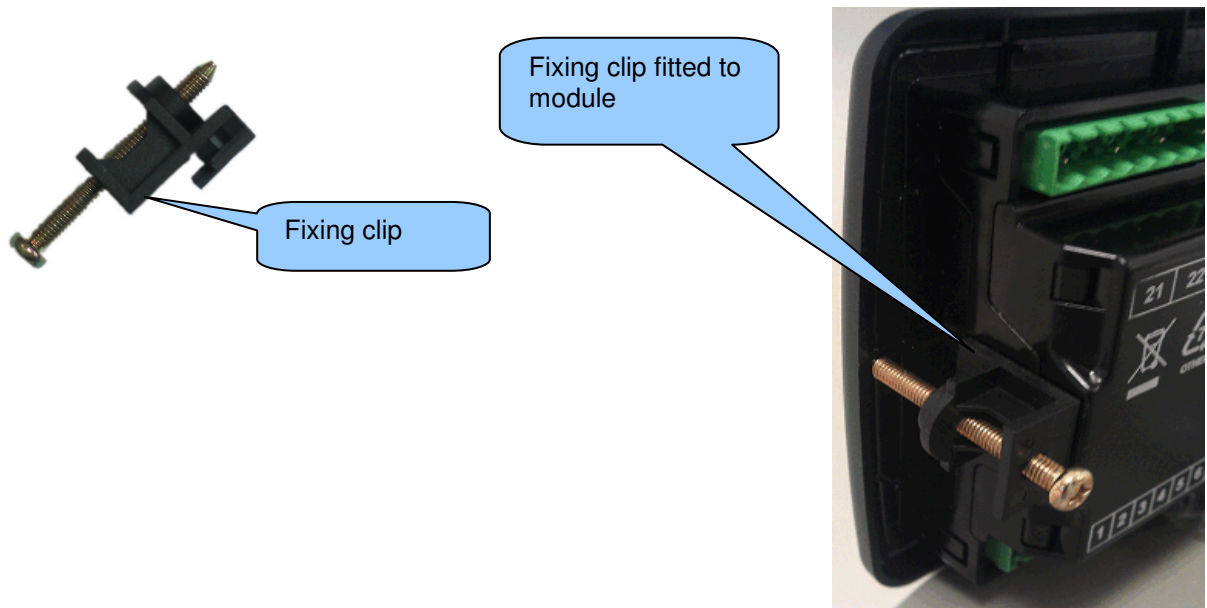

NOTE: In conditions of excessive vibration, mount the module on suitable anti-vibration mountings.

3.11.5 SILICON SEALING GASKET

The supplied silicon gasket provides improved sealing between module and the panel fascia. The gasket is fitted to the module before installation into the panel fascia. Take care to ensure the gasket is correctly fitted to the module to maintain the integrity of the seal.

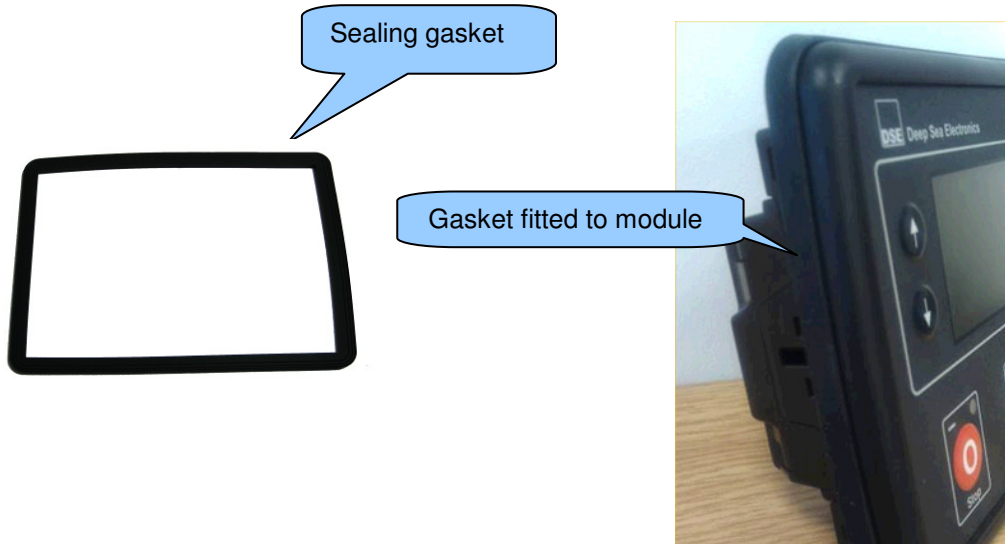

3.12 APPLICABLE STANDARDS

BS 4884-1	This document conforms to BS4884-1 1992 Specification for presentation of essential information.
BS 4884-2	This document conforms to BS4884-2 1993 Guide to content
BS 4884-3	This document conforms to BS4884-3 1993 Guide to presentation
BS EN 60068-2-1 (Minimum temperature)	-30°C (-22°F)
BS EN 60068-2-2 (Maximum temperature)	+70°C (158°F)
BS EN 60950	Safety of information technology equipment, including electrical business equipment
BS EN 61000-6-2	EMC Generic Immunity Standard (Industrial)
BS EN 61000-6-4	EMC Generic Emission Standard (Industrial)
BS EN 60529 (Degrees of protection provided by enclosures)	IP65 (front of module when installed into the control panel with the supplied sealing gasket) IP42 (front of module when installed into the control panel WITHOUT being sealed to the panel)
UL508 NEMA rating (Approximate)	12 (Front of module when installed into the control panel with the supplied sealing gasket). 2 (Front of module when installed into the control panel WITHOUT being sealed to the panel)
IEEE C37.2 (Standard Electrical Power System Device Function Numbers and Contact Designations)	<p>Under the scope of IEEE 37.2, <i>function numbers can also be used to represent functions in microprocessor devices and software programs.</i> The controller is device number 11L-8000 (Multifunction device protecting Line (generator) –module).</p> <p>As the module is configurable by the generator OEM, the functions covered by the module will vary. Under the module's factory configuration, the device numbers included within the module are :</p> <ul style="list-style-type: none"> 2 – Time delay starting or closing relay 6 – Starting circuit breaker 30 – annunciator relay 42 – Running circuit breaker 54 – turning gear engaging device 62 – time delay stopping or opening relay 63 – pressure switch 74– alarm relay 81 – frequency relay 86 – lockout relay

3.12.1 ENCLOSURE CLASSIFICATIONS

IP CLASSIFICATIONS

The modules specification under **BS EN 60529** Degrees of protection provided by enclosures

IP65 (Front of module when module is installed into the control panel with the optional sealing gasket).

IP42 (front of module when module is installed into the control panel WITHOUT being sealed to the panel)

First Digit	Second Digit
Protection against contact and ingress of solid objects	Protection against ingress of water
0 No protection	0 No protection
1 Protected against ingress solid objects with a diameter of more than 50 mm. No protection against deliberate access, e.g. with a hand, but large surfaces of the body are prevented from approach.	1 Protection against dripping water falling vertically. No harmful effect must be produced (vertically falling drops).
2 Protected against penetration by solid objects with a diameter of more than 12 mm. Fingers or similar objects prevented from approach.	2 Protection against dripping water falling vertically. There must be no harmful effect when the equipment (enclosure) is tilted at an angle up to 15° from its normal position (drops falling at an angle).
3 Protected against ingress of solid objects with a diameter of more than 2.5 mm. Tools, wires etc. with a thickness of more than 2.5 mm are prevented from approach.	3 Protection against water falling at any angle up to 60° from the vertical. There must be no harmful effect (spray water).
4 Protected against ingress of solid objects with a diameter of more than 1 mm. Tools, wires etc. with a thickness of more than 1 mm are prevented from approach.	4 Protection against water splashed against the equipment (enclosure) from any direction. There must be no harmful effect (splashing water).
5 Protected against harmful dust deposits. Ingress of dust is not totally prevented but the dust must not enter in sufficient quantity to interfere with satisfactory operation of the equipment. Complete protection against contact.	5 Protection against water projected from a nozzle against the equipment (enclosure) from any direction. There must be no harmful effect (water jet).
6 Protection against ingress of dust (dust tight). Complete protection against contact.	6 Protection against heavy seas or powerful water jets. Water must not enter the equipment (enclosure) in harmful quantities (splashing over).

3.12.2 NEMA CLASSIFICATIONS

The modules NEMA Rating (Approximate)

12 (Front of module when module is installed into the control panel with the optional sealing gasket).

2 (front of module when module is installed into the control panel WITHOUT being sealed to the panel)

 **NOTE: There is no direct equivalence between IP / NEMA ratings. IP figures shown are approximate only.**

1 IP30	Provides a degree of protection against contact with the enclosure equipment and against a limited amount of falling dirt.
2 IP31	Provides a degree of protection against limited amounts of falling water and dirt.
3 IP64	Provides a degree of protection against windblown dust, rain and sleet; undamaged by the formation of ice on the enclosure.
3R IP32	Provides a degree of protection against rain and sleet;; undamaged by the formation of ice on the enclosure.
4 (X) IP66	Provides a degree of protection against splashing water, windblown dust and rain, hose directed water; undamaged by the formation of ice on the enclosure. (Resist corrosion).
12/12K IP65	Provides a degree of protection against dust, falling dirt and dripping non corrosive liquids.
13 IP65	Provides a degree of protection against dust and spraying of water, oil and non corrosive coolants.

4 INSTALLATION

The module is designed to be mounted on the panel fascia. For dimension and mounting details, see the section entitled *Specification, Dimension and mounting* elsewhere in this document.

4.1 TERMINAL DESCRIPTION

To aid user connection, icons are used on the rear of the module to help identify terminal functions. An example of this is shown below.

NOTE: Availability of some terminals depends upon module version. Full details are given in the section entitled *Terminal Description* elsewhere in this manual.

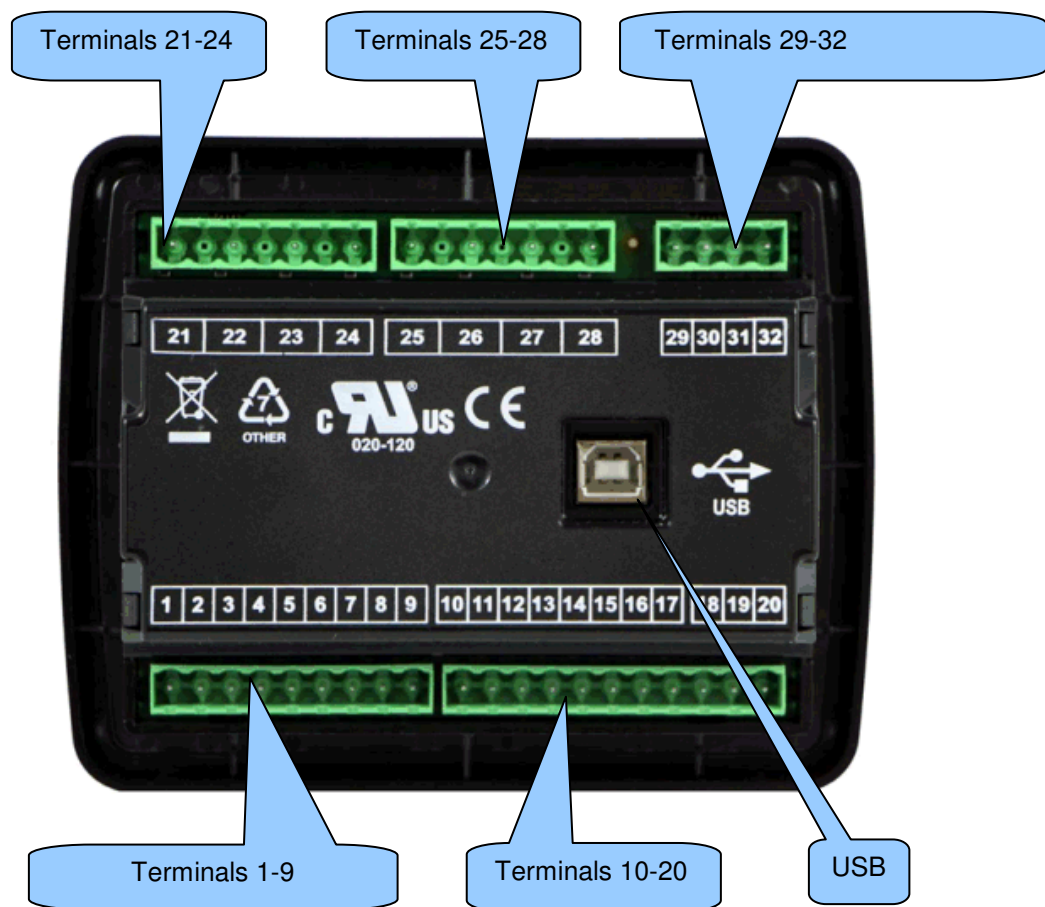

4.1.1 DC SUPPLY, FUEL AND START OUTPUTS, OUTPUTS C,D,E & F

PIN No	DESCRIPTION	CABLE SIZE	NOTES
1	DC Plant Supply Input (Negative)	2.5mm ² AWG 13	
2	DC Plant Supply Input (Positive)	2.5 mm ² AWG 13	(Recommended Maximum Fuse 15A anti-surge) Supplies the module (2A anti-surge requirement) and Output relays E,F,G & H
3	Output relay A (FUEL)	2.5mm ² AWG 13	Plant Supply Positive from terminal 3. 15 Amp rated. Fixed as FUEL relay if electronic engine is not configured.
4	Output relay B (START)	2.5mm ² AWG 13	Plant Supply Positive from terminal 3. 15 Amp rated. Fixed as START relay if electronic engine is not configured.
5	Charge fail / excite	2.5mm ² AWG 13	Do not connect to ground (battery negative). If charge alternator is not fitted, leave this terminal disconnected.
6	Output relay C	1.0mm ² AWG 18	Plant Supply Positive from terminal 2. 2 Amp rated.
7	Output relay D	1.0mm ² AWG 18	Plant Supply Positive from terminal 2. 2 Amp rated.
8	Output relay E	1.0mm ² AWG 18	Plant Supply Positive from terminal 2. 2 Amp rated.
9	Output relay F	1.0mm ² AWG 18	Plant Supply Positive.from terminal 2. 2 Amp rated.



NOTE: Output relays E & F (terminals 8 & 9) are not fitted to DSE4510 controller.



NOTE: When the module is configured for operation with an electronic engine, FUEL and START output requirements may be different. Refer to Publication: Part No. 057-004. Electronic Engines and DSE Wiring.

4.1.2 ANALOGUE SENSOR

PIN No	DESCRIPTION	CABLE SIZE	NOTES
10	Sensor Common Return	0.5mm ² AWG 20	Return feed for sensors*
11	Oil Pressure Input	0.5mm ² AWG 20	Connect to Oil pressure sensor
12	Coolant Temperature Input	0.5mm ² AWG 20	Connect to Coolant Temperature sensor
13	Flexible sensor	0.5mm ² AWG 20	Connect to additional sensor (user configurable)



NOTE: It is VERY important that terminal 10 (sensor common) is soundly connected to an earth point on the ENGINE BLOCK, not within the control panel, and must be a sound electrical connection to the sensor bodies. This connection MUST NOT be used to provide an earth connection for other terminals or devices. The simplest way to achieve this is to run a SEPARATE earth connection from the system earth star point, to terminal 15 directly, and not use this earth for other connections.

4.1.3 CONFIGURABLE DIGITAL INPUTS

PIN No	DESCRIPTION	CABLE SIZE	NOTES
14	Configurable digital input A	0.5mm ² AWG 20	Switch to negative
15	Configurable digital input B	0.5mm ² AWG 20	Switch to negative
16	Configurable digital input C	0.5mm ² AWG 20	Switch to negative
17	Configurable digital input D	0.5mm ² AWG 20	Switch to negative

 **NOTE: See the software manual for full range of configurable inputs available.**

4.1.4 CAN

PIN No	DESCRIPTION	CABLE SIZE	NOTES
18	CAN port H	0.5mm ² AWG 20	Use only 120Ω CAN approved cable
19	CAN port L	0.5mm ² AWG 20	Use only 120Ω CAN approved cable
20	Can port common	0.5mm ² AWG 20	Use only 120Ω CAN approved cable

 **NOTE: Screened 120Ω impedance cable specified for use with CAN must be used for the CAN link. DSE stock and supply Belden cable 9841 which is a high quality 120Ω impedance cable suitable for CAN use (DSE part number 016-030)**

4.1.5 GENERATOR / MAINS VOLTAGE SENSING

PIN No	DESCRIPTION	CABLE SIZE	NOTES
21	Generator L1 (U) voltage monitoring	1.0mm ² AWG 18	Connect to generator L1 (U) output (AC) (Recommend 2A fuse)
22	Generator L2 (V) voltage monitoring	1.0mm ² AWG 18	Connect to generator L2 (V) output (AC) (Recommend 2A fuse)
23	Generator L3 (W) voltage monitoring	1.0mm ² AWG 18	Connect to generator L3 (W) output (AC) (Recommend 2A fuse)
24	Generator Neutral (N) input	1.0mm ² AWG 18	Connect to generator Neutral terminal (AC)
25	Mains L1 (R) voltage monitoring	1.0mm ² AWG 18	Connect to Mains L1 (R) output (AC) (Recommend 2A fuse)
26	Mains L2 (S) voltage monitoring	1.0mm ² AWG 18	Connect to Mains L2 (S) output (AC) (Recommend 2A fuse)
27	Mains L3 (T) voltage monitoring	1.0mm ² AWG 18	Connect to Mains L3 (T) output (AC) (Recommend 2A fuse)
28	Mains Neutral (N) input	1.0mm ² AWG 18	Connect to Mains Neutral terminal (AC)

 **NOTE: The above table describes connections to a three phase, four wire alternator. For alternative wiring topologies, please see the ALTERNATIVE AC TOPOLOGIES section of this manual.**

 **NOTE: Terminals 25 – 28 not fitted to DSE4510**

4.1.6 GENERATOR CURRENT TRANSFORMERS

NOTE: Current Sensing (terminals 29-32) is not fitted to 4510-01 / 4520-01.

WARNING! Do not disconnect this plug when the CTs are carrying current. Disconnection will open circuit the secondary of the C.T.'s and dangerous voltages may then develop. Always ensure the CTs are not carrying current and the CTs are short circuit connected before making or breaking connections to the module.

NOTE: The module has a burden of 0.5VA on the CT. Ensure the CT is rated for the burden of the controller, the cable length being used and any other equipment sharing the CT. If in doubt, consult your CT supplier.

PIN No	DESCRIPTION	CABLE SIZE	NOTES
29	CT Secondary for Gen L1	2.5mm ² AWG 13	Connect to s1 secondary of L1 monitoring CT
30	CT Secondary for Gen L2	2.5mm ² AWG 13	Connect to s1 secondary of L2 monitoring CT
31	CT Secondary for Gen L3	2.5mm ² AWG 13	Connect to s1 secondary of L3 monitoring CT
32	CT Common	2.5mm ² AWG 13	

CT CONNECTIONS

p1, ξ or K is the primary of the CT that 'points' towards the GENERATOR



p2, ℓ or L is the primary of the CT that 'points' towards the LOAD

s1 is the secondary of the CT that connects to the DSE Module's input for the CT measuring (I1,I2,I3)

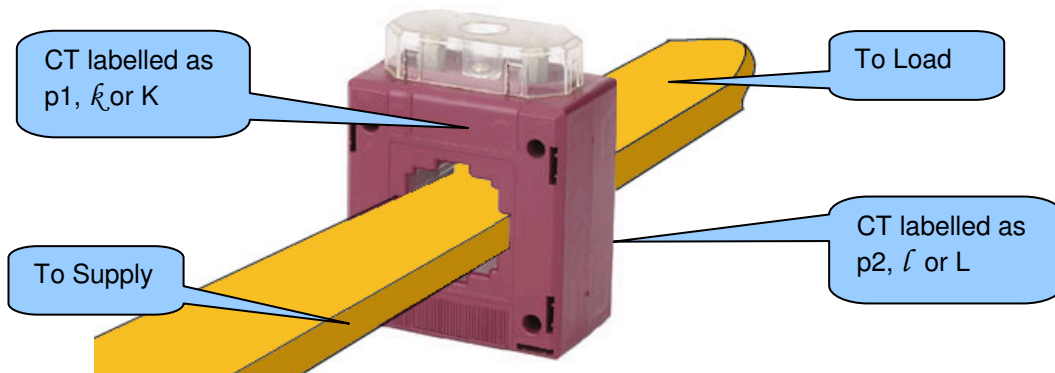
s2 is the secondary of the CT that should be commoned with the s2 connections of all the other CTs and connected to the CT common terminal of the module.



4.1.7 PC CONFIGURATION INTERFACE CONNECTOR

	DESCRIPTION	CABLE SIZE	NOTES
	<p>Socket for connection to PC with DSE Configuration Suite Software and remote communication.</p>	<p>0.5mm² AWG 20</p>	<p>This is a standard USB type A to type B connector.</p> 

▲ NOTE: The USB connection cable between the PC and the module must not be extended beyond 5m (yards). For distances over 5m, it is possible to use a third party USB extender. Typically, they extend USB up to 50m (yards). The supply and support of this type of equipment is outside the scope of Deep Sea Electronics PLC.

! CAUTION!: Care must be taken not to overload the PC's USB system by connecting more than the recommended number of USB devices to the PC. For further information, consult your PC supplier.

4.2 TYPICAL WIRING DIAGRAMS

As every system has different requirements, these diagrams show only a TYPICAL system and do not intend to show a complete system.

Genset manufacturers and panel builders may use these diagrams as a starting point; however, you are referred to the completed system diagram provided by your system manufacturer for complete wiring detail.

Further wiring suggestions are available in the following DSE publications, available at www.deepseapl.com to website members.

DSE PART	DESCRIPTION
056-022	Breaker Control (Training guide)
057-004	Electronic Engines and DSE Wiring

4.2.1 DSE4510 AUTOSTART MODULE

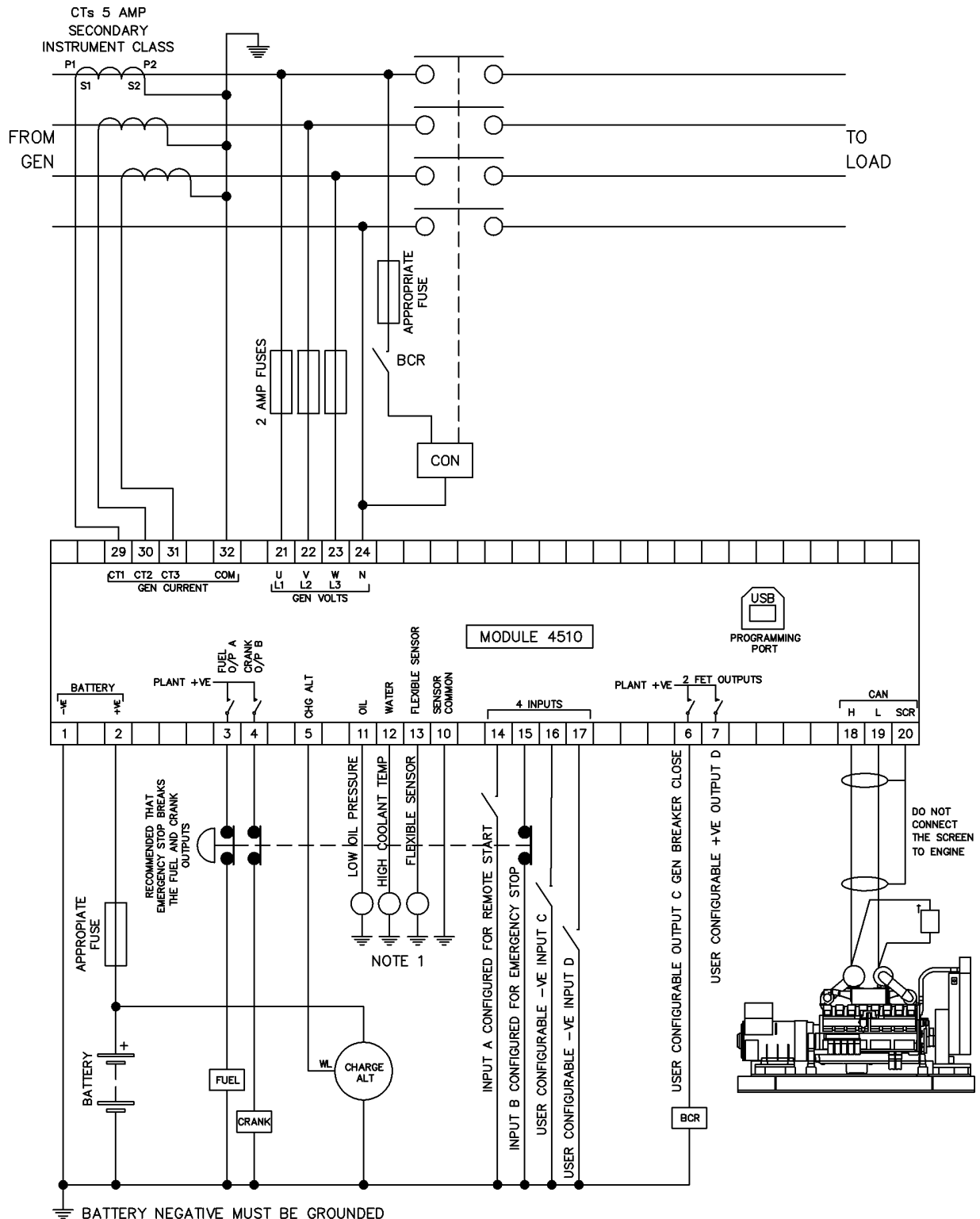

BATTERY NEGATIVE MUST BE GROUNDED

TERMINALS SUITABLE FOR 22-16 AWG (0.6mm - 1.3mm) FIELD WIRING
TIGHTENING TORQUE = 0.8Nm (7lb-in)

NOTE 1. THESE GROUND CONNECTIONS MUST BE ON THE ENGINE BLOCK, AND MUST BE TO THE SENDER BODIES. NOTE 2. 120 R TERMINATING RESISTOR MAY BE REQUIRED EXTERNALLY, SEE ENGINE MANUFACTURERS LITERATURE.

NOTE: Terminals 29-32 not fitted on 4510-01

4.2.2 DSE4520 AUTO MAINS FAILURE MODULE

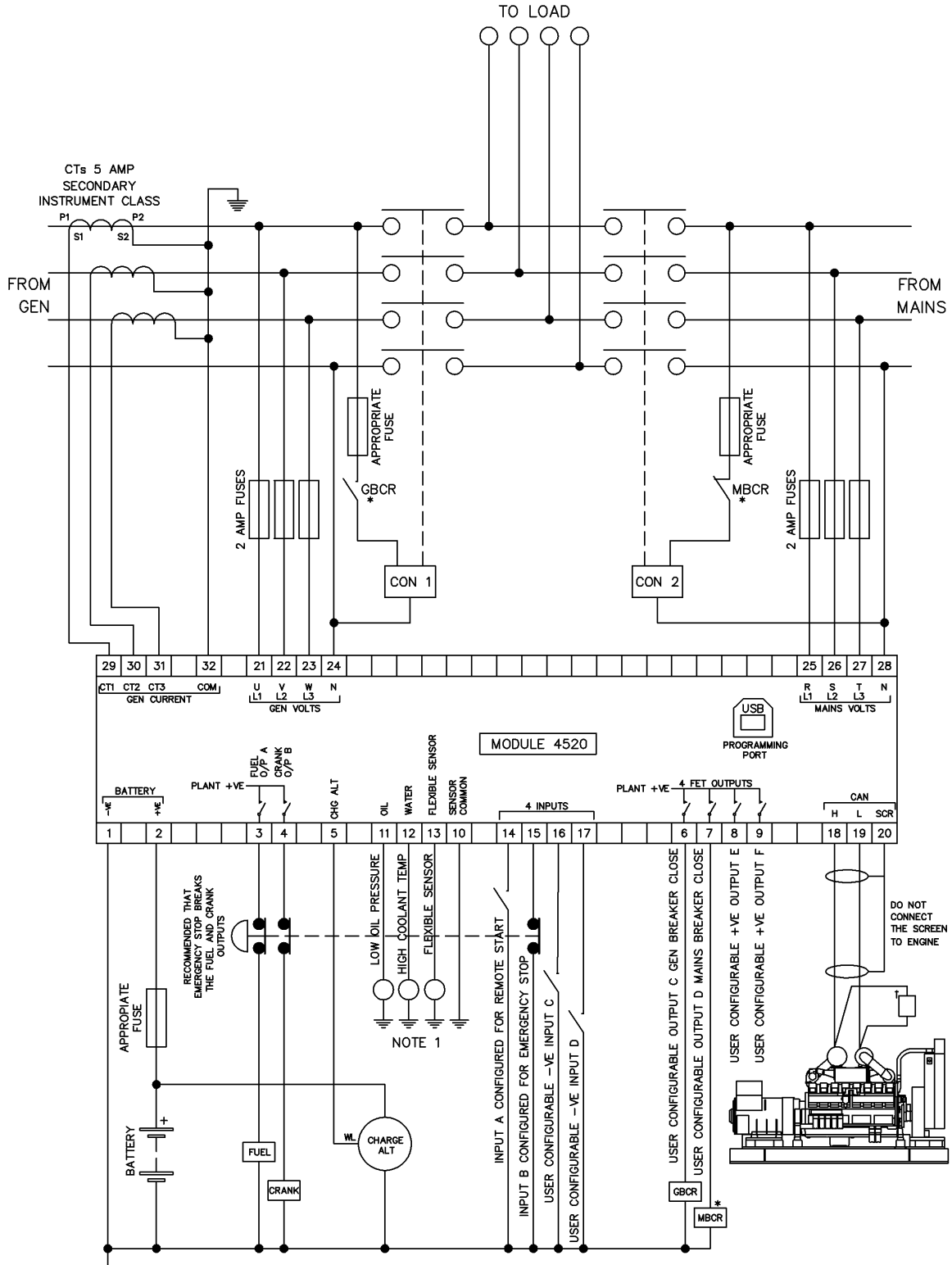

BATTERY NEGATIVE MUST BE GROUNDING

TERMINALS SUITABLE FOR 22-16 AWG (0.6mm – 1.3mm) FIELD WIRING
TIGHTENING TORQUE = 0.8Nm (7lb-in)

NOTE 1. THESE GROUND CONNECTIONS MUST BE ON THE ENGINE BLOCK, AND MUST BE TO THE SENDER BODIES.

NOTE 3. IT IS RECOMMENDED THAT THE GENERATOR AND MAINS SWITCHING DEVICES ARE MECHANICALLY AND ELECTRICALLY INTERLOCKED.

† NOTE 2. 120 R TERMINATING RESISTOR MAY BE REQUIRED EXTERNALLY, SEE ENGINE MANUFACTURERS LITERATURE.

* NOTE 4. MAINS BREAKER CLOSED OUTPUT SHOULD BE CONFIGURED FOR DE-ENERGISE CLOSE MAINS, AND USE THE NORMALLY CLOSED CONTACTS OF MBCR

NOTE: Terminals 29-32 not fitted on 4520-01





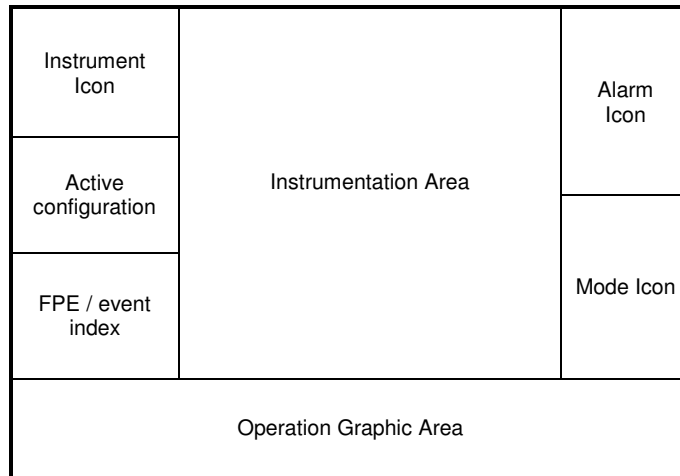











5 MODULE DISPLAY

The module's display contains





5.1 INSTRUMENTATION ICONS

When displaying instrumentation a small icon is displayed in the instrumentation area to indicate what value is currently being displayed.

Icon	Description
	Generator voltage and generator frequency
	Mains voltages and mains frequency
	Current
	Engine speed
	Engine running hours
	Battery voltage
	Oil pressure
	Coolant temperature
	Flexible sensor
	Appears when the event log is being displayed
	Current time held in the unit
	The current value of the scheduler run time and duration
	ECU diagnostic trouble codes
	Oil Filter maintenance timers
	Air Filter maintenance timers
	Fuel Filter maintenance timers









5.2 ACTIVE CONFIGURATION

An icon on the display shows the currently active configuration within the controller.

Icon	Details
	Appears when the main configuration is selected.
	Appears when the alternative configuration is selected.





5.3 MODE ICON

An icon is displayed in the mode icon area of the display to indicate what mode the unit is currently in.

Icon	Details
	Appears when the engine is at rest and the unit is in stop mode.
	Appears when the engine is at rest and the unit is in auto mode.
	Appears when the engine is at rest and the unit is in test mode.
	Appears when the engine is at rest and the unit is in armed mode.
	Appears when a timer is active, for example cranking time, crank rest etc.
	Appears when the engine is running, and all timers have expired, either on or off load. The animation speed is reduced when running in idle mode.
	Appears when the unit is in the front panel editor.
	Appears when a USB connection is made to the controller.
	Appears if either the configuration file or engine file becomes corrupted.

5.4 AUTO RUN ICON

When running in Auto Mode, an icon is shown on the home screen to identify why the engine is being run.

Icon	Auto run reason
	Remote start input
	Low battery run
	Scheduled run
	Mains failure

5.5 BACKLIGHT

The LCD backlight is on if the unit has sufficient voltage while the unit is turned on, unless the unit is cranking for which the backlight is turned off.

5.6 FAULT ICONS

ICON	DESCRIPTION	
	AUXILIARY INPUTS	Auxiliary inputs can be user configured and will display the message as written by the user.
	FAIL TO START	The engine has not fired after the preset number of start attempts
	FAIL TO STOP	The module has detected a condition that indicates that the engine is running when it has been instructed to stop. ▲ NOTE: 'Fail to Stop' could indicate a faulty oil pressure sensor - If engine is at rest check oil sensor wiring and configuration.
	LOW OIL PRESSURE	The module detects that the engine oil pressure has fallen below the low oil pressure pre-alarm setting level after the Safety On timer has expired.
	ENGINE HIGH TEMPERATURE	The module detects that the engine coolant temperature has exceeded the high engine temperature pre-alarm setting level after the Safety On timer has expired.
	UNDERSPEED	The engine speed has fallen below the underspeed pre alarm setting
	OVERSPEED	The engine speed has risen above the overspeed pre alarm setting
	CHARGE FAILURE	The auxiliary charge alternator voltage is low as measured from the W/L terminal.
	LOW FUEL LEVEL	The level detected by the fuel level sensor is below the low fuel level setting.
	BATTERY UNDER VOLTAGE / BATTERY OVER VOLTAGE	The DC supply has fallen below or risen above the low/high volts setting level.
	GENERATOR UNDER VOLTAGE	The generator output voltage has fallen below the pre-set pre-alarm setting after the Safety On timer has expired.
	GENERATOR OVER VOLTAGE	The generator output voltage has risen above the pre-set pre-alarm setting.
	GENERATOR UNDER FREQUENCY	The generator output frequency has fallen below the pre-set pre-alarm setting after the Safety On timer has expired.
	GENERATOR OVER FREQUENCY	The generator output frequency has risen above the pre-set pre-alarm setting.
	CAN ECU WARNING CAN ECU SHUTDOWN	The engine ECU has detected an alarm – CHECK ENGINE LIGHT Contact Engine Manufacturer for support.
	CAN DATA FAIL	The module is configured for CAN operation and does not detect data on the engine Can data link.
	EMERGENCY STOP	The emergency stop button has been depressed. This failsafe (normally closed to emergency stop) input and will immediately stop the set should the signal be removed.
	OIL SENDER OPEN CIRCUIT	Oil pressure sensor has been detected as being open circuit.
	FLEXIBLE SENSOR	The flexible sensor shutdown alarm has been triggered.
	OVERCURRENT	The current has risen above the set limit trip.
	OIL FILTER MAINTENANCE ALARM	Maintenance due for oil filter.
	AIR FILTER MAINTENANCE ALARM	Maintenance due for air filter
	FUEL FILTER MAINTENANCE ALARM	Maintenance due for fuel filter.

6 DESCRIPTION OF CONTROLS

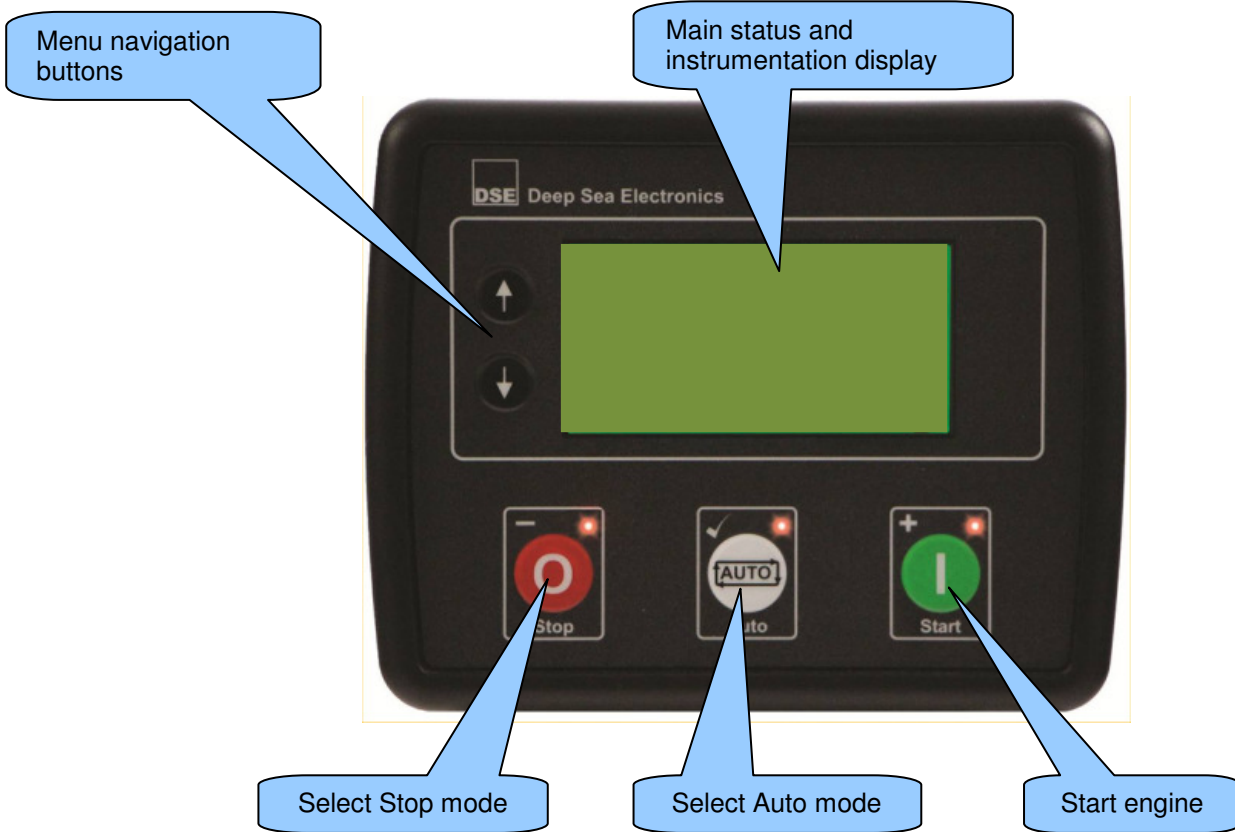

6.1 QUICKSTART GUIDE

This section provides a quick start guide to the module's operation.

6.1.1 STARTING THE ENGINE

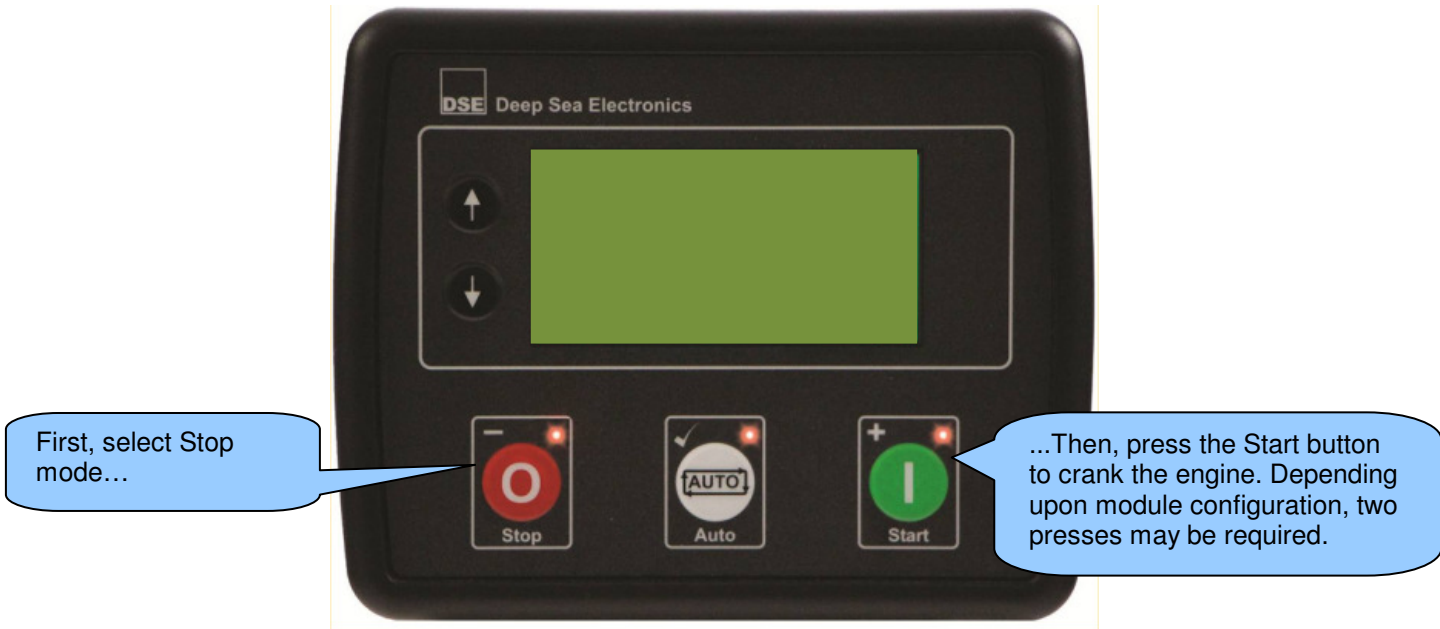



NOTE: For further details, see the section entitled 'OPERATION' elsewhere in this manual.

6.1.2 STOPPING THE ENGINE



NOTE: For further details, see the section entitled 'OPERATION' elsewhere in this manual.

6.2 VIEWING THE INSTRUMENT PAGES

It is possible to scroll to display the different pages of information by repeatedly operating the page buttons.  (previous) and  (next).

Example:

When viewing the Home page, press the  (down) button to change to the Generator instrument page.

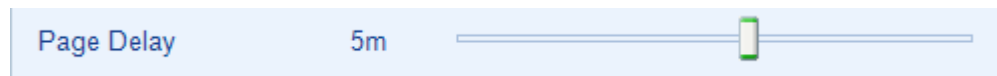

Once selected the page will remain on the LCD display until the user selects a different page, or after an extended period of inactivity (*Page Delay Timer*), the module will revert to the status display.

The *Page Delay Timer* is configurable using the DSE Configuration Suite Software or by using the Front Panel Editor.



NOTE: For further details of module configuration, see DSE Publication: 057-172. DSE4510 / DSE4520 Software Manual.









6.2.1 MENU

Alternatively you can enter the menu by holding down both  (up) and  (down) buttons simultaneously. The menu is then displayed.



Press the  (up) or  (down) buttons to select the required icon, then press  (✓) to enter the page.

If an alarm becomes active while viewing the status page, the display shows the Alarms page to draw the operator's attention to the alarm condition.

Icon	Description
	Home
	Generator instrumentation
	Mains instrumentation
	Load instrumentation (4510-02 / 4520-02 only)
	Engine instrumentation
	Info
	Engine DTCs (Diagnostic Trouble Codes)
	Event

6.2.2 HOME

This is the page that is displayed when no other page has been selected, and the page that is automatically displayed after a period of inactivity (*Page Delay Timer*) of the module control buttons.

6.2.3 GENERATOR

Contains electrical values of the generator (alternator), measured or derived from the module's voltage and current inputs.

- Generator Voltage (ph-N)
- Generator Voltage (ph-ph)
- Generator Frequency
- Generator Current *
- Generator Total Load (kW) *
- Generator Load (kW) *
- Generator Total Load (kVA) *
- Generator Power Factor *
- Generator Power Factor Average *
- Generator Load (kWh, kVAh, kVArh) *

 **NOTE: * Not applicable to 4510-01 & 4520-01**

6.2.4 MAINS (DSE4520 ONLY)

- Mains Voltage (ph-N)
- Mains Voltage (ph-ph)
- Mains Frequency

6.2.5 ENGINE

Contains instrumentation gathered about the engine itself, some of which may be obtained using the CAN or other electronic engine link.

- Engine Speed
- Oil Pressure
- Coolant Temperature
- Engine Battery Volts
- Engine Run Time
- Engine Maintenance Due – Oil (If configured)
- Engine Maintenance Due – Air (If configured)
- Engine Maintenance Due – Fuel (If configured)









6.2.6 INFO

Contains information about the controller.

- Model number
- USB identification number
- Configured Engine Type
- Module's date and time
- Scheduler setting

6.2.7 ENGINE DTC

This page contains any active *Diagnostic Trouble Codes* that the engine ECU is currently generating. These are alarm conditions detected by the engine ECU and displayed by the DSE controller.









Icon	DTC meaning
	Check engine (unspecified) fault
	Overspeed
	Underspeed
	Oil pressure low
	Coolant temperature high
	Charge Alt high or low
	Low fuel
	Battery high or low

6.2.8 EVENT

Contains a list of the last 5 events.

7 OPERATION

7.1 CONTROL PUSH-BUTTONS

<p>Stop / Reset This button places the module into its Stop/Reset  mode. will clear any alarm conditions for which the triggering criteria have been removed. If the engine is running and the module is in Stop mode, the module will automatically instruct the changeover device to unload the generator ('Close Generator' becomes inactive (if used)). The fuel supply de-energises and the engine comes to a standstill. Should a remote start signal be present while operating in this mode, a remote start will <u>not</u> occur.</p>	
<p>Auto This button places the module into its 'Automatic' mode. This mode allows the module to control the function of the generator automatically. The module will monitor the <i>remote start</i> input and mains supply status and once a start request is made, the set will be automatically started and placed on load. Upon removal of the starting signal, the module will automatically transfer the load from the generator and shut the set down observing the <i>stop delay</i> timer and <i>cooling</i> timer as necessary. The module will then await the next start event. <i>For further details, please see the more detailed description of 'Auto operation' elsewhere in this manual.</i></p>	
<p>Start This button is only active in STOP/RESET mode. Pressing this button in manual or test mode will start the engine and run off load (manual) or on load (test). Pressing this button in STOP/RESET  mode will turn on the CAN engine ECU (when correctly configured and fitted to a compatible engine ECU)</p>	
<div style="border: 1px solid black; padding: 5px;"> <p> NOTE: Different modes of operation are possible - Please refer to your configuration source for details.</p> </div>	
<p>Menu navigation Used for navigating the instrumentation, event log and configuration screens. For further details, please see the more detailed description of these items elsewhere in this manual.</p>	 

7.2 STOP MODE

STOP mode is activated by pressing the  button.



In STOP  mode, the module will remove the generator from load (if necessary) before stopping the engine if it is already running.

If the engine does not stop when requested, the FAIL TO STOP alarm is activated (subject to the setting of the *Fail to Stop* timer). To detect the engine at rest the following must occur :

- Engine speed is zero as CANbus ECU (Electronic Engine).
- Generator frequency must be zero.
- Oil pressure switch must be closed to indicate low oil pressure.

When the engine has stopped, it is possible to send configuration files to the module from DSE Configuration Suite PC software and to enter the Front Panel Editor to change parameters.

Any latched alarms that have been cleared will be reset when STOP  mode is entered.

The engine will not be started when in STOP  mode. If remote start signals are given, the input is ignored until AUTO  mode is entered.

When configured to do so, when left in STOP  mode for the time set for `Power Save Mode` with no presses of the fascia buttons, the module enters Power Save Mode. To `wake` the module, press any fascia control button or a Remote Start input. The same is true for Deep Sleep Mode.

Power Save & Deep Sleep Modes in the DSE Configuration Suite Software

Power Save Mode Enable	<input checked="" type="checkbox"/>
Deep Sleep Mode Enable	<input checked="" type="checkbox"/>

 **NOTE: For further details, see DSE Publication: 057-172 DSE4510 / 4520 Software Manual.**



7.2.1 ECU OVERRIDE

 **NOTE:** ECU Override function is only applicable when the controller is configured for a CAN engine and *Protected Start* is enabled.

 **NOTE:** Depending upon system design, the ECU may be powered or unpowered when the module is in STOP mode. ECU override is only applicable if the ECU is unpowered when in STOP mode.

When the ECU is powered down (normal operation in STOP mode), it is not possible to read the diagnostic trouble codes or instrumentation. Additionally, it is not possible to use the engine manufacturers' configuration tools.



As the ECU is usually unpowered when the engine is not running, it must be turned on manually as follows :

- Select STOP  mode on the DSE controller.
- Press and hold the START  button to power the ECU. As the controller is in STOP mode, the engine will not be started.

This is also useful if the engine manufacturer's tools need to be connected to the engine, for instance to configure the engine as the ECU needs to be powered up to perform this operation.

7.3 AUTOMATIC MODE

NOTE: If a digital input configured to external *panel lock* is active, changing module modes will not be possible. Viewing the instruments and event logs is NOT affected by panel lock.

Activate auto mode by pressing the  pushbutton. The  icon is displayed to indicate Auto Mode operations if no alarms are present.

Auto mode will allow the generator to operate fully automatically, starting and stopping as required with no user intervention.

7.3.1 WAITING IN AUTO MODE

If a starting request is made, the starting sequence will begin. Starting requests can be from the following sources :

- Activation of an auxiliary input that has been configured to *remote start*
- Activation of the inbuilt exercise scheduler.
- Mains failure (DSE4520 only).

7.3.2 STARTING SEQUENCE

To allow for 'false' start requests, the *start delay* timer begins.

Should all start requests be removed during the *start delay* timer, the unit will return to a stand-by state.

If a start request is still present at the end of the *start delay* timer, the fuel relay is energised and the engine will be cranked.

NOTE: If the unit has been configured for CAN, compatible ECU's will receive the start command via CAN and transmit the engine speed to the DSE controller.

If the engine fails to fire during this cranking attempt then the starter motor is disengaged for the *crank rest* duration after which the next start attempt is made. Should this sequence continue beyond the set number of attempts, the start sequence will be terminated and the display shows  **Fail to Start**.

7.3.3 ENGINE RUNNING

Once the engine is running and all starting timers have expired, the animated  icon is displayed.

The generator will be placed on load if configured to do so.

NOTE: The load transfer signal remains inactive until the Oil Pressure has risen. This prevents excessive wear on the engine.

If all start requests are removed, the *stopping sequence* will begin.

7.3.4 STOPPING SEQUENCE

The *return delay* timer operates to ensure that the starting request has been permanently removed and isn't just a short term removal. Should another start request be made during the cooling down period, the set will return on load.

If there are no starting requests at the end of the *return delay* timer, the load is removed from the generator to the mains supply and the *cooling* timer is initiated.

The *cooling* timer allows the set to run off load and cool sufficiently before being stopped. This is particularly important where turbo chargers are fitted to the engine.

After the *cooling* timer has expired, the set is stopped.



7.4 MANUAL MODE

NOTE: If a digital input configured to panel lock is active, changing module modes will not be possible. Viewing the instruments and event logs is NOT affected by panel lock.

Manual mode allows the operator to start and stop the set manually, and if required change the state of the load switching devices. . Module mode is active when the  button is pressed.

7.4.1 WAITING IN MANUAL MODE

To begin the starting sequence, press the  button. If '*protected start*' is disabled, the start sequence begins immediately.

If 'Protected Start' is enabled, the  icon is displayed to indicate Manual mode and the manual LED flashes. The  button must be pressed once more to begin the start sequence.

Protected Start Mode



Protected Start Mode setting in the DSE Configuration Suite Software

NOTE: For further details, see the Publication: 057-172 DSE4510/4520 Software Manual.

7.4.2 STARTING SEQUENCE

NOTE: There is no *start delay* in this mode of operation.

The fuel relay is energised and the engine is cranked.

NOTE: If the unit has been configured for CAN, compatible ECU's will receive the start command via CAN.

If the engine fails to fire during this cranking attempt then the starter motor is disengaged for the *crank rest* duration after which the next start attempt is made. Should this sequence continue beyond the set number of attempts, the start sequence will be terminated and the display shows **Fail to Start**.

When the engine fires, the starter motor is disengaged. Speed detection is factory configured to be derived from the main alternator output frequency.

Additionally, rising oil pressure can be used disconnect the starter motor (but cannot detect under speed or over speed).

After the starter motor has disengaged, the *Safety On* timer activates, allowing Oil Pressure, High Engine Temperature, Under-speed, Charge Fail and any delayed Auxiliary fault inputs to stabilise without triggering the fault.



7.4.3 ENGINE RUNNING

In manual mode, the load is not transferred to the generator unless a 'loading request' is made. A loading request can come from a number of sources.

- Mains supply out of limits (DSE4520 only)
- Activation of an auxiliary input that has been configured to *remote start on load*
- Activation of the inbuilt exercise scheduler if configured for 'on load' runs.

 **NOTE: The load transfer signal remains inactive until the Oil Pressure has risen. This prevents excessive wear on the engine.**



Once the load has been transferred to the generator, it will not be automatically transferred back to the mains supply. To manually transfer the load back to the mains either:

- Press the *auto mode*  button to return to automatic mode. The set will observe all auto mode start requests and stopping timers before beginning the *Auto mode stopping sequence*.
- Press the *stop button* 
- De-activation of an auxiliary input that has been configured to *remote start on load*

For further details of breaker control, see the section entitled "controls and indications" elsewhere in this manual.

7.4.4 STOPPING SEQUENCE

In manual mode the set will continue to run until either :

- The *stop button*  is pressed – The set will immediately stop
- The *auto button*  is pressed. The set will observe all auto mode start requests and stopping timers before beginning the *Auto mode stopping sequence*.

7.5 MAINTENANCE ALARM

Depending upon module configuration one or more levels of maintenance alarm may occur based upon a configurable schedule.

Example 1

Screen capture from DSE Configuration Suite Software showing the configuration of Maintenance Alarm for Oil, Air or Fuel.

When activated, the maintenance alarm can be either a **warning** (set continues to run) or **shutdown** (running the set is not possible). Resetting the maintenance alarm is normally actioned by the site service engineer after performing the required maintenance. The method of reset is either by:

- Activating an input that has been configured to maintenance x reset, where x is the number of the maintenance alarm (Oil, Air or Fuel).
- Pressing the maintenance reset button in the DSE Configuration Suite, Maintenance section.

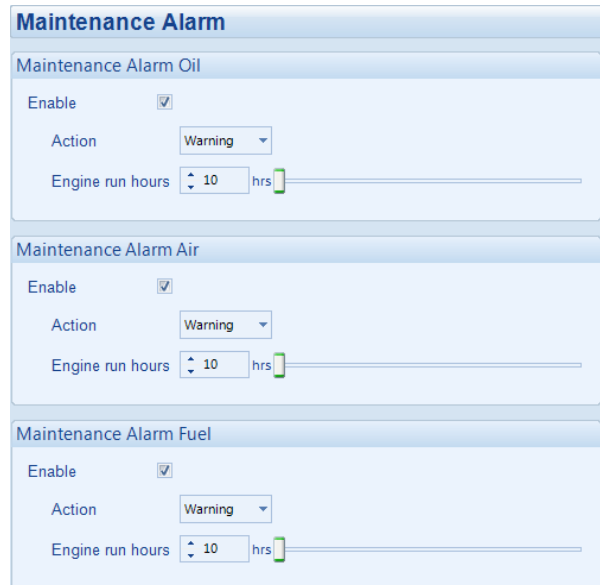

Example 2

Screen capture from DSE Configuration Suite Software showing the configuration of a digital input for Maintenance Rest Alarm Oil.

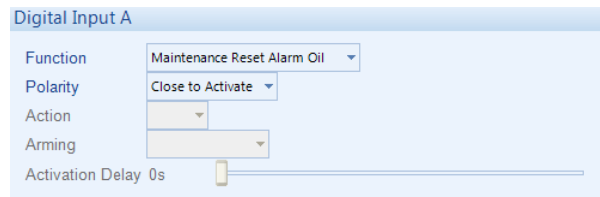

Example 3

Screen capture from DSE Configuration Suite Software showing the Maintenance Alarm Reset 'button' in the DSE Configuration Suite SCADA | MAINTENANCE section.

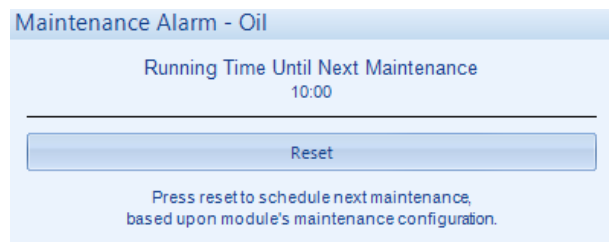

8 SCHEDULER

The controller contains an inbuilt exercise run scheduler, capable of automatically starting and stopping the set. Scheduled run may be on load or off load depending upon module configuration.

Example

Screen capture from DSE Configuration Suite Software showing the configuration of the Exercise Scheduler.





In this example the set will start at 09:00 on Monday and run for 5 hours.

The screenshot shows the 'Exercise Scheduler' configuration window. It features a title bar, a 'Enabled' checkbox, a 'Scheduled run repeat interval' dropdown menu set to '1 week', and a 'Scheduled run is On Load' checkbox. Below these are three input fields: 'Day' (Monday), 'Start Time' (09:00), and 'Duration' (05:00). A 'Clear' button is located at the bottom right of the configuration area.

8.1.1 STOP MODE

- Scheduled runs will not occur when the module is in STOP/RESET  mode.

8.1.2 AUTO MODE

- Scheduled runs will operate ONLY if the module is in AUTO  mode with no Shutdown or Electrical Trip alarm present.
- If the module is in STOP  mode when a scheduled run begins, the engine will not be started. However, if the module is moved into AUTO  mode during a scheduled run, the engine will be called to start.
- Depending upon configuration by the system designer, an external input can be used to inhibit a scheduled run.
- If the engine is running OFF LOAD in AUTO  mode and a scheduled run configured to 'On Load' begins, the set is placed ON LOAD for the duration of the Schedule.

9 FRONT PANEL CONFIGURATION

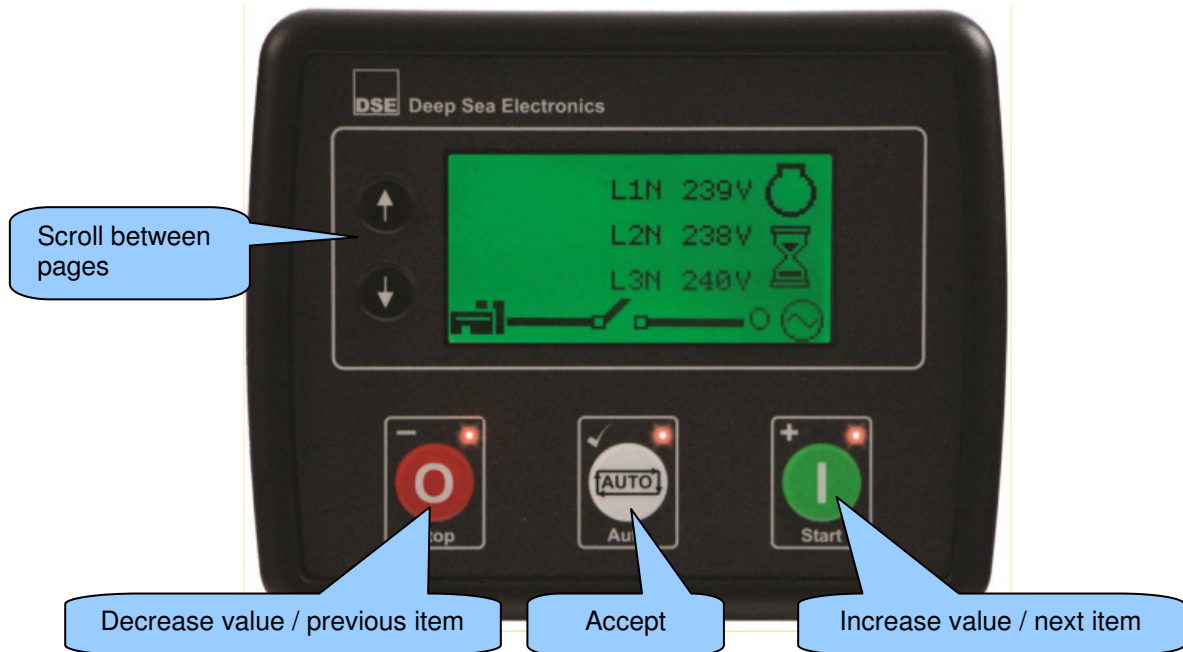

This configuration mode allows the operator limited customising of the way the module operates.

Use the module's navigation buttons to navigate the menu and make changes to the settings:



9.1 ACCESSING THE FRONT PANEL CONFIGURATION EDITOR

Ensure the engine is at rest and the module is in STOP mode by pressing the Stop/Reset  button.

Press the Stop/Reset  and Auto  buttons simultaneously.

If a module security PIN has been set, the PIN number request is then shown :

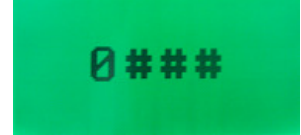

Press  (up) or  (down) buttons to adjust it to the correct value.

Press  (Start) when the first digit is correctly entered. The digit you have just entered will now show '#' for security.

Repeat this process for the other digits of the PIN number. You can press  (Stop) if you need to move back to adjust one of the previous digits.

When  is pressed after editing the final PIN digit, the PIN is checked for validity. If the number is not correct, you must re-enter the PIN.

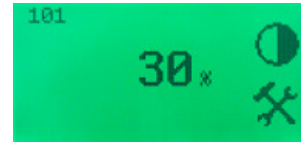

If the PIN has been successfully entered (or the module PIN has not been enabled), the editor is displayed :





 **NOTE:** The PIN number is not set by DSE when the module leaves the factory. If the module has a PIN code set, this has been affected by your generator supplier who should be contacted if you require the code. If the code has been 'lost' or 'forgotten', the module must be returned to the DSE factory to have the module's code removed. A charge will be made for this procedure.
NB - This procedure cannot be performed away from the DSE factory.

 **NOTE:** The PIN number is automatically reset when the editor is exited (manually or automatically) to ensure security.

To edit the parameter, press  (✓) to enter edit mode. The parameter begins to flash to indicate that you are editing the value.



Press  (up) or  (down) buttons to change the parameter to the required value.

Press  (✓) to save the value. The parameter ceases flashing to indicate that it has been saved.

To exit the editor at any time, press and hold the  (✓) button.

9.1.1 EDITING A PARAMETER

Enter the editor as described above.

Press  (up) or  (down) buttons to cycle to the section you wish to view/change.

Press the  button to select the next parameter you wish to view/change within the currently selected section.

 **NOTE: The editor automatically exits after 5 minutes of inactivity to ensure security.**

9.2 ADJUSTABLE PARAMETERS

CONFIGURATION PARAMETERS- MODULE (PAGE 1)					
101	Contrast	000 (%)	111	Display ph-ph	On (1), Off (0)
102	Fast Loading Enabled	On (1), Off (0)	112	Pin Number	0000
103	All Warnings Latched	On (1), Off (0)	113	Stop Button Cooldown	On (1), Off (0)
104	Lamp Test at Start-up	On (1), Off (0)	114	Use Module Oil Pressure	On (1), Off (0)
105	Power Save Mode Enable	On (1), Off (0)	115	Use Module Coolant Temperature	On (1), Off (0)
106	Deep Sleep Mode Enable	On (1), Off (0)	116	Use Module Engine Hours	On (1), Off (0)
107	Protected Start Enabled	On (1), Off (0)	117	Use Module RPM	On (1), Off (0)
108	Event Log Display Format	On (1), Off (0)	118	Use Module Chg Alt	On (1), Off (0)
109	Start Mode	0 (Mode)	119	Disable TSC1 Speed Feed	On (1), Off (0)
110	DTC String Enable	On (1), Off (0)			

CONFIGURATION PARAMETERS- APPLICATION (PAGE 2)					
201	Alternative Engine Speed	On (1), Off (0)	203	CAN ECU Data Fail Action	0 (Action)
202	CAN ECU Data Fail Enable	On (1), Off (0)	204	CAN ECU Data Fail Delay	0 s

CONFIGURATION PARAMETERS – INPUTS (PAGE 3)		
301	Low Oil Pressure Enable	On (1), Off (0)
302	Low Oil Pressure Trip	0% / 0.00 Bar / 0 Deg C
303	High Engine Temperature Trip	00 Deg C / 00 Deg F
304	Digital Input A Source	0 (Input Source)
305	Digital Input A Polarity	0 (Polarity)
306	Digital Input A Action (If Source = User Configured)	0 (Action)
307	Digital Input A Arming (If Source = User Configured)	0 (Arming)
308	Digital Input A Activation Delay (If Source = User Configured)	0:00
309	Digital Input B Source	0 (Input Source)
310	Digital Input B Polarity	0 (Polarity)
311	Digital Input B Action (If Source = User Configured)	0 (Action)
312	Digital Input B Arming (If Source = User Configured)	0 (Arming)
313	Digital Input B Activation Delay (If Source = User Configured)	0:00
314	Digital Input C Source	0 (Input Source)
315	Digital Input C Polarity	0 (Polarity)
316	Digital Input C Action (If Source = User Configured)	0 (Action)
317	Digital Input C Arming (If Source = User Configured)	0 (Arming)
318	Digital Input C Activation Delay (If Source = User Configured)	0:00
319	Digital Input D Source	0 (Input Source)
320	Digital Input D Polarity	0 (Polarity)
321	Digital Input D Action (If Source = User Configured)	0 (Action)
322	Digital Input D Arming (If Source = User Configured)	0 (Arming)
323	Digital Input D Activation Delay (If Source = User Configured)	0:00
324	Analogue Input A Sensor Type	0 (Sensor Type)
325	Analogue Input A Sensor Selection (Pressure Sensor List)	0 (Pressure Sensor)
326	Analogue Input A (Set As Digital) Source (Oil Pressure Sender)	0 (Input Source)
327	Analogue Input A (Set As Digital) Polarity	0 (Polarity)
328	Analogue Input A (Set As Digital) Action (If Source = User Configured)	0 (Action)
329	Analogue Input A (Set As Digital) Arming (If Source = User Configured)	0 (Arming)
330	Analogue Input A (set as digital) activation delay (if source = user Configured)	0:00
331	Analogue Input B Sensor Type	0 (Sensor Type)
332	Analogue Input B Sensor Selection (Temperature Sensor List)	0 (Temp Sensor)
333	Analogue Input B (Set As Digital) Source (Temperature Sender)	0 (Input Source)
334	Analogue Input B Polarity (Set As Digital)	0 (Polarity)
335	Analogue Input B (Set As Digital) Action (If Source = User Configured)	0 (Action)
336	Analogue Input B (Set As Digital) Arming (If Source = User Configured)	0 (Arming)
337	Analogue Input B (Set As Digital) Activation Delay (If Source = User Configured)	0:00
338	Analogue Input C Sensor Type	0 (Sensor Type)
339	Analogue Input C Sensor Selection (Pressure / Temp / Percentage)	0 (Sensor)
340	Analogue Input C (Set As Digital) Source (Flexible Sender)	0 (Input Source)
341	Analogue Input C (Set As Digital) Polarity	0 (Polarity)
342	Analogue Input C (Set As Digital) Action (If Source = User Configured)	0 (Action)
343	Analogue Input C (Set As Digital) Arming (If Source = User Configured)	0 (Arming)
344	Analogue Input C (Set As Digital) Activation Delay (If Source = User Configured)	0:00
345	Oil Pressure Sender Open Circuit Alarm	On (1), Off (0)
346	Temperature Sender Open Circuit Alarm	On (1), Off (0)

Front Panel Configuration

CONFIGURATION PARAMETERS – OUTPUTS (PAGE 4)			
401	Digital Output A Source	0 (Output Source)	
402	Digital Output A Polarity	0 (Output Source Polarity)	
403	Digital Output B Source	0 (Output Source)	
404	Digital Output B Polarity	0 (Output Source Polarity)	
405	Digital Output C Source	0 (Output Source)	
406	Digital Output C Polarity	0 (Output Source Polarity)	
407	Digital Output D Source	0 (Output Source)	
408	Digital Output D Polarity	0 (Output Source Polarity)	
409	Digital Output E Source	0 (Output Source)	
410	Digital Output E Polarity	0 (Output Source Polarity)	
411	Digital Output F Source	0 (Output Source)	
412	Digital Output F Polarity	0 (Output Source Polarity)	

NOTE: = DSE4520 ONLY

Input and Output Configuration Tables are Included Elsewhere in this Section.

CONFIGURATION PARAMETERS – TIMERS (PAGE 5)					
501	Mains Transient Delay	509	Warm Up Time	517	Breaker Close Pulse
502	Start Delay	510	Return Delay	518	Delayed Load 1
503	Preheat Timer	511	Cooling Time	519	Delayed Load 2
504	Crank Time	512	ETS Solenoid Hold	520	Delayed Load 3
505	Crank Rest Time	513	Failed To Stop Delay	521	Delayed Load 4
506	Smoke Limiting	514	Generator Transient Delay	522	Power Save Mode Delay
507	Smoke Limiting Off	515	Transfer Time	523	Deep Sleep Mode Delay
508	Safety On Delay	516	Breaker Trip Pulse	524	Page Timer

CONFIGURATION PARAMETERS – GENERATOR (PAGE 6)					
601	Alternator Fitted	On (1), Off (0)	617	Reserved	
602	Alternator Poles	0	618	Loading Frequency	0.0 Hz
603	Under Voltage Shutdown Enable	On (1), Off (0)	619	Nominal Frequency	0.0 Hz
604	Under Voltage Trip Shutdown	0 V	620	Over Frequency Warning Enable	On (1), Off (0)
605	Under Voltage Warning Enable	On (1), Off (0)	621	Over Freq Warning Warning Return	0.0 Hz
606	Under Voltage Warning Trip	0 V	622	Over Frequency Warning Trip	0.0 Hz
607	Reserved		623	Over Frequency Shutdown Enable	On (1), Off (0)
608	Loading Voltage	0 V	624	Over Frequency Shutdown Trip	0.0 Hz
609	Over Voltage Warning Enable	On (1), Off (0)	625	AC System	0 (AC System)
610	Over Voltage Warning Return	0 V	626	CT Primary	0 Amps
611	Over Voltage Warning Trip	0 V	627	Full Load Rating	0 Amps
612	Over Voltage Shutdown Trip	0 V	628	Immediate Over Current Enable	On (1), Off (0)
613	Under Frequency Shutdown Enable	On (1), Off (0)	629	Delayed Over Current Alarm Enable	On (1), Off (0)
614	Under Frequency Shutdown Trip	0.0 Hz	630	Delayed Over Current Alarm Action	0 (Action)
615	Under Frequency Warning Enable	On (1), Off (0)	631	Delay Over Current Time	0:00:00
616	Under Frequency Warning Trip	0.0 Hz	632	Delayed Over Current Trip Level	0 %









NOTE: = 4510-02 / 4520-02 ONLY



CONFIGURATION PARAMETERS – MAINS (PAGE 7 – DSE4520 ONLY)					
701	AC System	AC System (See Table)	709	Over Voltage Level Trip	0 V
702	Mains Failure Detection	On (1), Off (0)	710	Under Frequency Enable	On (1), Off (0)
703	Immediate Mains Dropout	On (1), Off (0)	711	Under Frequency Trip	0.0 Hz
704	Under Voltage Enable	On (1), Off (0)	712	Under Frequency Return	0.0 Hz
705	Under Voltage Level	0 V	713	Over Frequency Enable	On (1), Off (0)
706	Under Voltage Return	0 V	714	Over Frequency Return	0 Hz
707	Over Voltage Enable	On (1), Off (0)	715	Over Frequency Trip	0.0 Hz
708	Over Voltage Return	0 V			

Front Panel Configuration

CONFIGURATION PARAMETERS – ENGINE (PAGE 8)		
801	Start Attempts	0
802	Overspeed Overshoot	0 %
803	Overspeed Delay	0 s
804	Gas Choke Timer (Gas Engine Only)	0 s
805	Gas On Delay (Gas Engine Only)	0 s
806	Gas Ignition Off Delay (Gas Engine Only)	0 s
807	Crank Disconnect On Oil Pressure Enable	On (1), Off (0)
808	Check Oil Pressure Prior To Starting	On (1), Off (0)
809	Crank Disconnect On Oil Threshold	0.00 Bar
810	Crank Disconnect On Frequency	0.0 Hz
811	Crank Disconnect On Engine Speed	0000 rpm
812	Under Speed Enable	On (1), Off (0)
813	Under Speed Trip	0000 rpm
814	Over Speed Trip	0000 rpm
815	Low Battery Volts Enable	On (1), Off (0)
816	Low Battery Volts Trip	00.0 V
817	Low Battery Volts Return	00.0 V
818	Low Battery Volts Delay	0:00:00
819	High Battery Volts Enable	On (1), Off (0)
820	High Battery Volts Return	00.0 V
821	High Battery Volts Trip	00.0 V
822	High Battery Volts Warning Delay	00.0 V
823	Charge Alt Shutdown Enable	On (1), Off (0)
824	Charge Alt Shutdown Trip	00.0 V
825	Charge Alt Shutdown Trip Delay	0:00:00
826	Charge Alt Warning Trip Enable	On (1), Off (0)
827	Charge Alt Warning Trip	00.0 V
828	Charge Alt Warning Trip Delay	0:00:00
829	Low Battery Start Arming	On (1), Off (0)
830	Low Battery Start Threshold	00.0 V
831	Low Battery Start Delay	0:00:00
832	Low Battery Start Run Time	0:00:00

Front Panel Configuration

CONFIGURATION PARAMETERS – ALTERNATIVE CONFIGURATION (PAGE 9)			
901	Default Configuration	Main (1), Alternative (0)	
902	Alternative Configuration – Enable Configuration	On (1), Off (0)	
903	Alternative Configuration – Alternative Engine Speed	On (1), Off (0)	
904	Alternative Configuration – Under Voltage Shutdown Enable	On (1), Off (0)	
905	Alternative Configuration – Under Voltage Shutdown Trip	0 V	
906	Alternative Configuration – Under Voltage Warning Enable	On (1), Off (0)	
907	Alternative Configuration – Under Voltage Warning Trip	0 V	
908	Alternative Configuration – Under Voltage Warning Return	0 V	
909	Alternative Configuration – Loading Voltage	0 V	
910	Alternative Configuration – Over Voltage Warning Enabled	On (1), Off (0)	
911	Alternative Configuration – Over Voltage Warning Trip	0 V	
912	Alternative Configuration – Over Voltage Warning Return	0 V	
913	Alternative Configuration – Over Voltage Trip	0 V	
914	Alternative Configuration – Under Frequency Shutdown Enable	On (1), Off (0)	
915	Alternative Configuration – Under Frequency Shutdown Trip	0.0 Hz	
916	Alternative Configuration – Under Freq Warning Enable	On (1), Off (0)	
917	Alternative Configuration – Under Frequency Warning Trip	0.0 Hz	
918	Reserved		
919	Alternative Configuration – Loading Frequency	0.0 Hz	
920	Alternative Configuration – Nominal Frequency	0.0 Hz	
921	Alternative Configuration – Over Frequency Warning Enable	On (1), Off (0)	
922	Alternative Configuration – Over Frequency Warning Trip	0.0 Hz	
923	Alternative Configuration – Over Frequency Warning Return	0.0 Hz	
924	Alternative Configuration – Over Frequency Shutdown Enable	On (1), Off (0)	
925	Alternative Configuration – Over Frequency Shutdown Trip	0.0 Hz	
926	Alternative Configuration – CT Primary	0 Amps	
927	Alternative Configuration – Current Full Load Rating	0 Amps	
928	Alternative Configuration – Current Immediate Overcurrent Enable	On (1), Off (0)	
929	Alternative Configuration – Current Delayed Alarm Enable	On (1), Off (0)	
930	Alternative Configuration – Current Delayed Alarm Action	0 (Action)	
931	Alternative Configuration – Current Delay Timer	0:00:00	
932	Alternative Configuration – Current Trip %	0 %	
933	Alternative Configuration – AC System	AC System (See Table)	
934	Alternative Configuration – Mains Failure Detection	On (1), Off (0)	
935	Alternative Configuration – Immediate Mains Dropout	On (1), Off (0)	
936	Alternative Configuration – Mains Under Voltage Enable	On (1), Off (0)	
937	Alternative Configuration – Mains Under Voltage Trip Level	0 V	
938	Alternative Configuration – Mains Under Volt Return	0V	
939	Alternative Configuration – Mains Over Volt Enable	On (1), Off (0)	
940	Alternative Configuration – Mains Over Volt Return	0V	
941	Alternative Configuration – Mains Over Volt Trip	0V	
942	Alternative Configuration – Mains Under Frequency Enable	On (1), Off (0)	
943	Alternative Configuration – Mains Under Frequency Trip	0.0 Hz	
944	Alternative Configuration – Mains Under Frequency Return	0.0 Hz	
945	Alternative Configuration – Mains Over Frequency Enable	On (1), Off (0)	
946	Alternative Configuration – Mains Over Frequency Return	0.0 Hz	
947	Alternative Configuration – Mains Over Frequency Trip	0.0 Hz	
948	Alternative Configuration – Alternative Under Speed Shutdown Enable	On (1), Off (0)	
949	Alternative Configuration – Alternative Under Speed Shutdown Trip	0000 rpm	
950	Alternative Configuration – Alternative Overspeed Shutdown Trip	0000 rpm	

 **NOTE:**  = 4510-02 / 4520-02 ONLY

 **NOTE:**  = DSE4520 ONLY





Front Panel Configuration

CONFIGURATION PARAMETERS – FLEXIBLE SENSOR (PAGE 10)		
1001	Flexible Sensor Alarm Arming	0 (Arming)
1002	Flexible Sensor - Low Alarm Enable	0 (Action)
1003	Flexible Sensor - Low Alarm Trip (Units Depend Upon Sensor Type)	0 % / 0.00 Bar / 0 °C
1004	Flexible Sensor - High Alarm Enable	0 (Action)
1005	Flexible Sensor - High Alarm Trip (Units Depend Upon Sensor Type)	0 % / 0.00 Bar / 0 °C

CONFIGURATION PARAMETERS – SCHEDULER (PAGE 11)					
1101	Enable Scheduler	On (1), Off (0)	1104	Day	0 (Day, 1=Monday)
1102	On Load or Off Load	On (1), Off (0)	1105	Duration	0:00:00
1103	Start Time	0:00:00	1106	Week	1,2,3,4

CONFIGURATION PARAMETERS – TIME AND DAY (PAGE 12)					
1201	Time Of Day	0:00	1203	Week Of Year	1-52
1202	Day Of Week	(0 Day,1=Monday)			

CONFIGURATION PARAMETERS – MAINTENANCE (PAGE 13)		
1301	Maintenance Alarm (Oil) Enable	On (1), Off (0)
1302	Maintenance Alarm (Oil) Action	0 (Action)
1303	Maintenance Alarm (Oil) Engine Hours	0:00
1304	Maintenance Alarm (Air) Enable	On (1), Off (0)
1305	Maintenance Alarm (Air) Action	0 (Action)
1306	Maintenance Alarm (Air) Engine Hours	0:00
1307	Maintenance Alarm (Fuel) Enable	On (1), Off (0)
1308	Maintenance Alarm (fuel) Action	0 (Action)
1309	Maintenance Alarm (fuel) Engine hours	0:00

INPUT SOURCE LIST							
0	User Configured		10	Generator load Inhibit		20	Simulate Start button
1	Alarm Mute		11	Lamp Test		21	Smoke Limiting
2	Alarm Reset		12	Low Fuel Level Switch		22	Close Gen / Open Mains
3	Alternative Configuration		13	Mains Load Inhibit		23	Close Mains / Open Gen
4	Auto Restore Inhibit		14	Oil Pressure Switch		24	Maintenance Reset Air
5	Auto Start Inhibit		15	Remote Start Off Load		25	Maintenance Reset Fuel
6	Auxiliary Mains Fail		16	Remote Start On Load		26	Maintenance Reset Oil
7	Coolant Temperature Switch		17	Simulate Mains Available			
8	Emergency Stop		18	Simulate Stop button			
9	External Panel Lock		19	Simulate Auto button			

 **NOTE:**  = DSE4520 ONLY

Front Panel Configuration

INPUT ACTION LIST	
Index	Action
0	Electrical Trip
1	Shutdown
2	Warning

INPUT POLARITY LIST	
Index	Action
0	Close to Activate
1	Open to Activate

FLEXIBLE SENSOR ALARM ACTION LIST	
Index	Type
0	None
1	Shutdown
2	Electrical Trip

FLEXIBLE SENSOR TYPE LIST	
Index	Type
0	None
1	Digital Input
2	Percentage Sensor
3	Pressure Sensor
4	Temperature Sensor

INPUT ARMING LIST	
Index	Arming
0	Always
1	From Safety On
2	From Starting
3	Never

OUTPUT POLARITY LIST	
Index	Arming
0	Energise
1	De-energise

AC SYSTEM LIST	
Index	Type
0	2 Phase 3 wire (L1-L2)
1	2 phase 3 wire (L1-L3)
2	3 phase 3 wire
3	3 phase 4 wire
4	3 phase 4 wire (Delta)
5	Single Phase 2 wire



POWER UP MODE	
Index	Mode
0	Stop
1	Manual
2	Auto







SENSOR SELECTIONS FOR PERCENTAGE	
0	Not Used
1	Digital switch Closed for Alarm
2	Digital switch Open for Alarm
3	VDO ohm (10-180)
4	VDO Tube (90-0)
5	US ohm (240-33)
6	GM ohm (0-90)
7	GM ohm (0-30)
8	Ford (73-10)
9	User Defined

SENSOR SELECTIONS FOR OIL PRESSURE	
0	Not used
1	Digital switch Closed for Alarm
2	Digital switch Open for Alarm
3	VDO 5 bar
4	VDO 10 bar
5	Datcon 5 bar
6	Datcon 10 bar
7	Datcon 7 bar
8	Murphy 7 bar
9	CMB812
10	Veglia
11	User Defined

SENSOR SELECTIONS FOR COOLANT TEMPERATURE	
0	Not Used
1	Digital switch Closed for Alarm
2	Digital switch Open for Alarm
3	VDO 120 °C
4	Datcon High
5	Datcon Low
6	Murphy
7	Cummins
8	PT100
9	Veglia
10	Beru
11	User Defined

Front Panel Configuration



OUTPUT SOURCE LIST		
0	Not Used	
1	Air Flap Relay	
2	Audible Alarm	
3	Battery Over Volts Warning	
4	Battery Under Volts Warning	
5	CAN ECU Data Fail	
6	CAN ECU Warning	
7	CAN ECU Shutdown	
8	CAN ECU Power	
9	CAN ECU Stop	
10	Charge Alternator Shutdown	
11	Charge Alternator Warning	
12	Close Gen Output	
13	Close Gen Output Pulse	
14	Close Mains Output	
15	Close Mains Output Pulse	
16	Combined Mains Failure	
17	Common Alarm	
18	Common Electrical Trip	
19	Common Shutdown	
20	Common Warning	
21	Cooling Down	
22	Digital Input A	
23	Digital Input B	
24	Digital Input C	
25	Digital Input D	
26	Digital Input E (Analogue Input A)	
27	Digital Input F (Analogue Input B)	
28	Digital Input G (Analogue Input C)	
29	Emergency Stop	
30	Energise to Stop	
31	Fail to Start	
32	Fail to Stop	
33	Fuel Relay	
34	Gas Choke On	
35	Gas Ignition	
36	Generator Available	
37	Generator Over Voltage Shutdown	
38	Generator Under Voltage shutdown	
39	Generator Overcurrent	
40	Generator Delayed Over Current	
41	High Coolant Temperature Shutdown	

OUTPUT SOURCE LIST		
42	Low Fuel Level	
43	Low Oil Pressure Shutdown	
44	Mains High frequency	
45	Mains High Voltage	
46	Mains Low Frequency	
47	Mains Low Voltage	
48	Oil pressure Open Circuit	
49	Open Gen Output	
50	Open Gen Output Pulse	
51	Open Mains Output	
52	Open Mains Output Pulse	
53	Over Frequency Shutdown	
54	Overspeed Shutdown	
55	Preheat During Preheat Timer	
56	Preheat Until End Of Crank	
57	Preheat Until End Of Safety Timer	
58	Preheat Until End Of Warming Timer	
59	Smoke Limiting	
60	Start Relay	
61	Temperature Sender Open Circuit	
62	Under Frequency Shutdown	
63	Under Speed Shutdown	
64	Waiting for Manual Restore	
65	Flexible Sender High Shutdown	
66	Flexible Sender High Warning	
67	Flexible Sender Low Warning	
68	Flexible Sender Low Shutdown	
69	Delayed Load Output 1	
70	Delayed Load Output 2	
71	Delayed Load Output 3	
72	Delayed Load Output 4	
73	Air Filter Maintenance Output	
74	Oil Filter Maintenance Output	
75	Fuel Filter Maintenance Output	
76	Stop Mode	
77	Auto Mode	
78	Manual Mode	

 **NOTE:**  = DSE4520 ONLY

9.3 PRE-COMMISSIONING

Before the system is started, it is recommended that the following checks are made:-

- The unit is adequately cooled and all the wiring to the module is of a standard and rating compatible with the system. Check all mechanical parts are fitted correctly and that all electrical connections (including earths) are sound.
- The unit **DC** supply is fused and connected to the battery and that it is of the correct polarity.
- The Emergency Stop input (if configured) must be wired to an external **normally closed** switch connected to **DC Negative**
- To check the start cycle operation, take appropriate measures to prevent the engine from starting (disable the operation of the fuel solenoid). After a visual inspection to ensure it is safe to proceed, connect the battery supply. Press  the unit start sequence will commence.
- The starter will engage and operate for the pre-set crank period. After the starter motor has attempted to start the engine for the pre-set number of attempts, the LCD will display 'Failed to start. Select the  position to reset the unit.
- Restore the engine to operational status (reconnect the fuel solenoid). Press . This time the engine should start and the starter motor should disengage automatically. If not then check that the engine is fully operational (fuel available, etc.) and that the fuel solenoid is operating. The engine should now run up to operating speed. If not, and an alarm is present, check the alarm condition for validity, then check input wiring. The engine should continue to run for an indefinite period. It will be possible at this time to view the engine and alternator parameters - refer to the 'Description of Controls' section of this manual.
- Initiate an automatic start by supplying the remote start signal (if configured). The start sequence will commence and the engine will run up to operational speed. Once the generator is available a load transfer will take place (if configured), the Generator will accept the load. If not, check the wiring to the Generator Contactor (*if used*). Check the Warming timer has timed out.
- Remove the remote start signal. The return sequence will begin. After the pre-set time, the generator is unloaded. The generator will then run for the pre-set cooling down period, then shutdown into its standby mode.
- Set the modules internal clock/calendar to ensure correct operation of the scheduler and event logging functions. For details of this procedure see section entitled *Front Panel Configuration* .
- If, despite repeated checking of the connections between the controller and the customer's system, satisfactory operation cannot be achieved, then the customer is requested to contact the factory for further advice on:-

INTERNATIONAL TEL: +44 (0) 1723 890099

INTERNATIONAL FAX: +44 (0) 1723 893303

E-mail: Support@Deepseapl.com

Website : www.deepseapl.com

10 FAULT FINDING

SYMPTOM	POSSIBLE REMEDY
Unit is inoperative Read/Write configuration does not operate	Check the battery and wiring to the unit. Check the DC supply. Check the DC fuse.
Unit shuts down	Check DC supply voltage is not above 35 Volts or below 9 Volts Check the operating temperature is not above 70°C. Check the DC fuse.
Unit locks out on Emergency Stop	Check emergency stop switch is functioning correctly. Check Wiring is not open circuit.(if configured)
Low oil Pressure fault operates after engine has fired	Check engine oil pressure. Check oil pressure switch/sensor and wiring. Check configured polarity (if applicable) is correct (i.e. Normally Open or Normally Closed) or that sensor is compatible with the module and is correctly configured.
High engine temperature fault operates after engine has fired.	Check engine temperature. Check switch/sensor and wiring. Check configured polarity (if applicable) is correct (i.e. Normally Open or Normally Closed) or that sensor is compatible with the module.
Shutdown fault operates	Check relevant switch and wiring of fault indicated on LCD display. Check configuration of input.
Warning fault operates	Check relevant switch and wiring of fault indicated on LCD display. Check configuration of input.
Fail to Start is activated after pre-set number of attempts to start	Check wiring of fuel solenoid. Check fuel. Check battery supply. Check battery supply is present on the Fuel output of the module. Check the speed-sensing signal is present on the module inputs. Refer to engine manual.
Continuous starting of generator when in AUTO	Check that there is no signal present on the "Remote Start" input. Check configured polarity is correct.
Generator fails to start on receipt of Remote Start signal.	Check Start Delay timer has timed out. Check signal is on "Remote Start" input. Confirm correct configuration of input is configured to be used as "Remote Start". Check that the oil pressure switch or sensor is indicating low oil pressure to the controller. Depending upon configuration, the set will not start if oil pressure is not low.
Pre-heat inoperative	Check wiring to engine heater plugs. Check battery supply. Check battery supply is present on the Pre-heat output of module. Check pre-heat configuration is correct.
Starter motor inoperative	Check wiring to starter solenoid. Check battery supply. Check battery supply is present on the Starter output of module. Ensure that the Emergency Stop input is at Positive. Ensure oil pressure switch or sensor is indicating the "low oil pressure" state to the controller.
Engine runs but generator will not take load	Check Warm up timer has timed out. Ensure generator load inhibit signal is not present on the module inputs. Check connections to the switching device. Note that the set will not take load in manual mode unless there is an active remote start on load signal.

SYMPTOM	POSSIBLE REMEDY
Incorrect reading on Engine gauges Fail to stop alarm when engine is at rest	Check engine is operating correctly. Check sensor and wiring.
Set will not take load	Ensure the generator is available. Check that the output configuration is correct to drive the load switch device and that all connections are correct. Remember that the set will not take load in manual mode unless a remote start on load input is present.
Inaccurate generator measurements on controller display	The controller is true RMS measuring so gives more accurate display when compared with an 'average' meter such as an analogue panel meter or some lower specified digital multimeters. Accuracy of the controller is better than 1% of full scale. ie Gen volts full scale is 415V ph-n so accuracy is $\pm 4.15V$ (1% of 415V).

10.1 CAN

SYMPTOM	POSSIBLE REMEDY
CAN DATA FAIL	Indicates failure of the CAN data link to the engine ECU. Check all wiring and termination resistors (if required). Check the ECU OVERRIDE function detailed in the section entitled OPERATION elsewhere in this manual.

10.2 INSTRUMENTS

SYMPTOM	POSSIBLE REMEDY
Inaccurate generator measurements on controller display	Check that the CT primary, CT secondary and VT ratio settings are correct for the application. Check that the CTs are wired correctly with regards to the direction of current flow (p1,p2 and s1,s2) and additionally ensure that CTs are connected to the correct phase (errors will occur if CT1 is connected to phase 2). Remember to consider the power factor. ie (kW = kVA x powerfactor) The controller is true RMS measuring so gives more accurate display when compared with an 'averaging' meter such as an analogue panel meter or some lower specified digital multimeters. Accuracy of the controller is better than 1% of full scale. ie Gen volts full scale is 415V ph-n so accuracy is $\pm 4.15V$ (1% of 415V).

 **NOTE: Current sensing is not available on 4510-01 / 4520-01**

10.3 MISCELLANEOUS

SYMPTOM	POSSIBLE REMEDY
Module appears to 'revert' to an earlier configuration	<p>When editing a configuration using the PC software it is vital that the configuration is first 'read' from the controller before editing it. This edited configuration must then be "written" back to the controller for the changes to take effect.</p> <p>When editing a configuration using the fascia editor, be sure to press the  (✓) button to save the change before moving to another item or exiting the fascia editor</p>

▲ NOTE: The above fault finding is provided as a guide check-list only. As the module can be configured to provide a wide range of different features, always refer to the source of your module configuration if in doubt.

11 MAINTENANCE, SPARES, REPAIR AND SERVICING

The controller is *Fit and Forget*. As such, there are no user serviceable parts within the controller. In the case of malfunction, you should contact your original equipment manufacturer (OEM).

11.1 PURCHASING ADDITIONAL CONNECTOR PLUGS FROM DSE

If you require additional plugs from DSE, please contact our Sales department using the part numbers below.

11.1.1 PACK OF PLUGS

Module type	Plug Pack Part Number
4510-01	100-400-41
4520-01	100-400-42
4510-02	100-400-47
4520-02	100-400-46

11.1.2 INDIVIDUAL PLUGS

Module Terminal Designation	Plug Description	Part No.
1-9	DSE4520 Only 9 way 5.08mm	007-166
1-7	DSE4510 Only 7 way 5.08mm	007-155
10-20	11 way 5.08mm	007-451
21-24	4 way 10.16mm	007-003
25-28	DSE4520 Only 4 way 10.16mm	007-003
29-32	Not fitted on 4510-01 / 4520-01 4 way 5.08mm	007-282
	PC Configuration interface lead (USB type A – USB type B)	016-125

11.2 PURCHASING ADDITIONAL FIXING CLIPS FROM DSE

Item	Description	Part No.
	Module fixing clips (packet of 4)	020-294

11.3 PURCHASING ADDITIONAL SEALING GASKET FROM DSE

Item	Description	Part No.
	Module silicon sealing gasket	020-507

12 WARRANTY

DSE provides limited warranty to the equipment purchaser at the point of sale. For full details of any applicable warranty, you are referred to your original equipment supplier (OEM).

13 DISPOSAL

13.1 WEEE (WASTE ELECTRICAL AND ELECTRONIC EQUIPMENT)

Directive 2002/96/EC

If you use electrical and electronic equipment you must store, collect, treat, recycle and dispose of WEEE separately from your other waste.



13.2 ROHS (RESTRICTION OF HAZARDOUS SUBSTANCES)

Directive 2002/95/EC: 2006

To remove specified hazardous substances (Lead, Mercury, Hexavalent Chromium, Cadmium, PBB & PBDE's)

Exemption Note: Category 9. (Monitoring & Control Instruments) as defined in Annex 1B of the WEEE directive will be exempt from the RoHS legislation. This was confirmed in the August 2005 UK's Department of Trade and Industry RoHS REGULATIONS Guide (Para 11).

Despite this exemption, DSE has been carefully removing all non RoHS compliant components from our supply chain and products.

When this is completed, a Lead Free & RoHS compatible manufacturing process will be phased into DSE production.

This process that is almost complete and is being phased through different product groups.

This Page Is Intentionally Left Blank

This Page Is Intentionally Left Blank